



# IK-72W SERIES

## Rail traveling carriage for all position welding

### Features and Benefits

- **Light weight at 5.5 kg (W) / 7.6 kg (WEAVING)**
- **Two models:**
  - IK-72W: Tack welding
  - IK-72W WEAVING: Tack and weaving welding
- **Carriage positioning by limit switch**
- **Advanced tack welding functions**
- **Digitally controlled weaving and tack welding (Weaving model)**
- **Shares the same rail system as the cutting machine IK- 72T; making it possible to weld after cut.**

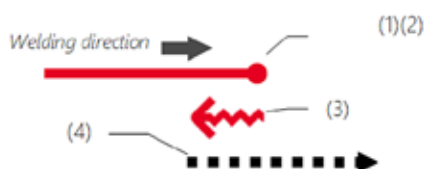

### The advanced tack controller

#### Controllable tack welding distance

- Tack and dry-run distance can be controlled during welding just by simple click on a toggle switch.
- Equipped with an encoder motor, the IK-72T calculates the travel distance by counting motor rotations, ensuring accurate distance control.
- All parameter values are shown on the digital display for easier parameter management and repeatability.

#### Crater filling function (\*)

(\*) Requires welding machine with crater function with matching control.

- Automatically switches to crater amperage at the end of each weld for crater fill sequence.

- 1) At the end of each weld, the carriage gives a signal to the welding power source to switch to the crater amperage.
- 2) Carriage stops for a set period of time.
- 3) With crater amperage, carriage welds backwards at a set speed for a set distance.
- 4) After the crater sequence, the carriage dry-runs to the starting point of the next tack weld (in tack welding mode).

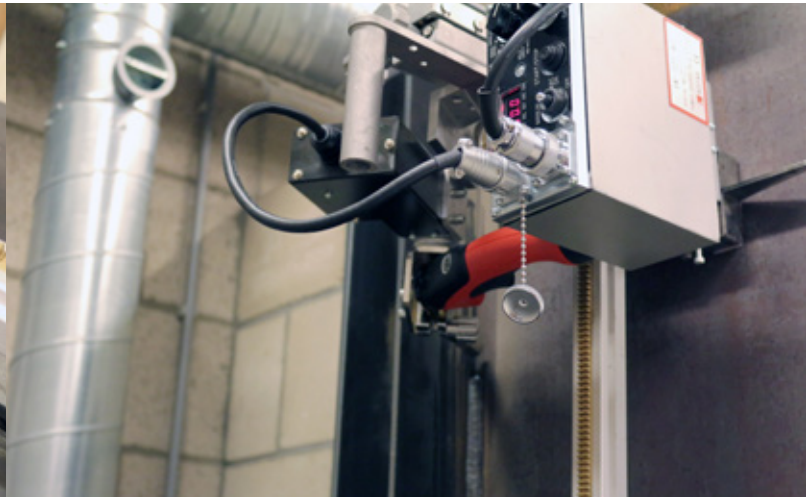

The IK-72W series is used for straight welding in horizontal and vertical positions using 1 dimensional rail and curved and twisted plane welding using 2 and 3 dimensional rails. By using same rail system as the cutting machine IK-72T, cutting and welding can be done with IK-72 system in convenient and lightweight package.

### WU-5R Weaving Unit (Option for IK-72W Standard with IK-72W WEAVING model)

Option for IK-72W to perform weaving welding. Includes mounting bracket. Weaving is controlled by encoder motor.

Weaving speed (\*) : 400 - 1500 mm/min

Weaving widths:(\*) : 0 - 100 mm/min

Stop timer (left/center/right) : 0.0 - 10.0 seconds

(\*) at radius=100mm from the center of rotation

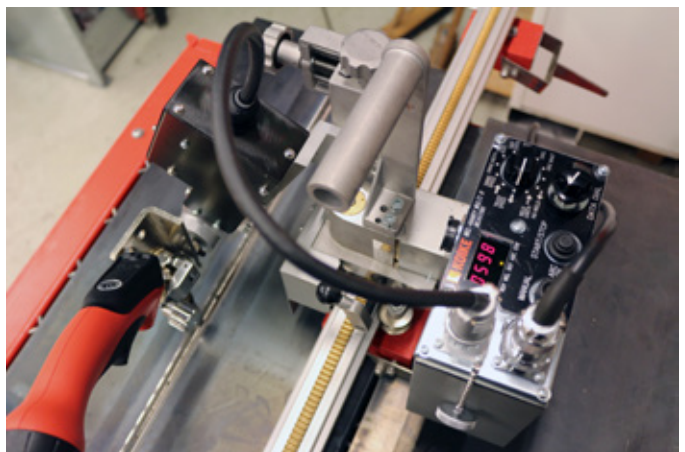

## Accessories

## Rail selections

Accessory	Stock #
IK-72T 1D-RAIL 1500 MM	TBPJ64025
IK-72T 2D-RAIL 1000 MM	90154
IK-72T 3D-RAIL 1000 MM	TBPJ64026

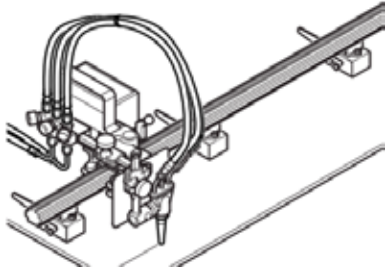

### 1D Rail 1500 mm

- For flat plate
- Extendable aluminium made straight rail
- Ideal for straight welding applications
- 4 pcs. permanent magnets

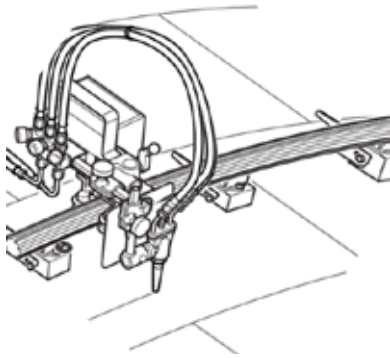
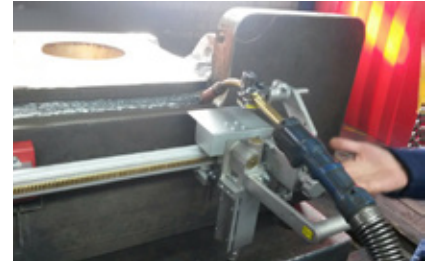

### 2D Rail 1000 mm

- For bended plane
- Extendable flexible rubber rail with steel plate liner; maximum bending radius 2500 mm
- 5 pcs. permanent magnets
- Upto 30° slope from horizontal position

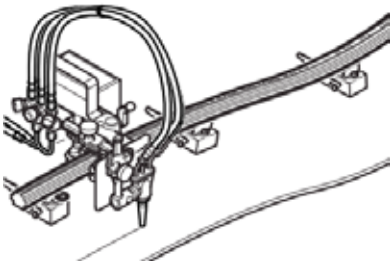
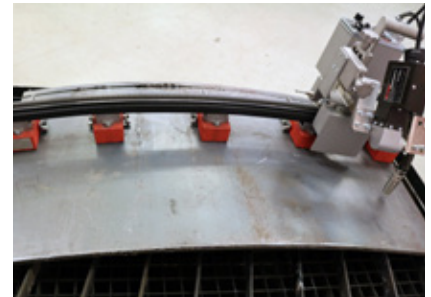

### 3D Rail 1000 mm

- For bended and twisted planes
- Extendable flexible rubber rail; bends in any directions
- Maximum bending radius 2000 mm
- 5 pcs. permanent magnets
- Upto 30° slope from horizontal position



## Optional accessories

Accessory	Stock #	Description
Rail connector	33107	Parts to connect 1D rail to 2D / 3D rail
Transformer PR 100-240V-SEC 24V 65W	222.002.256	Primary 100-240V / Secondary DC 24V
Weaving unit WU-5R	90255	

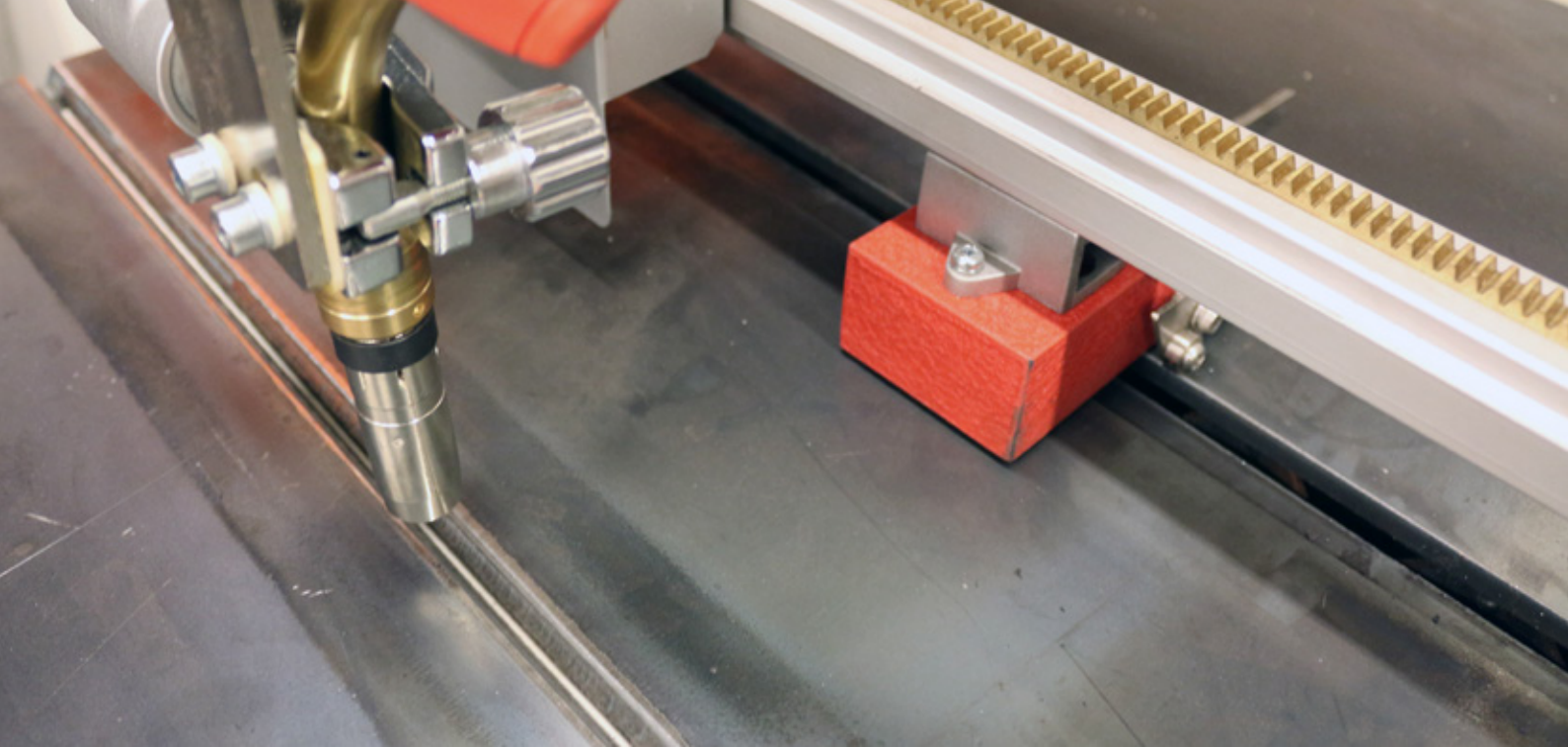

Specification		IK-72W	IK-72W WEAVING
Machine weight		5.5 kg	7.6 kg
Travel speed		20-600 mm/min	
Guiding method		IK-72 rail system	
Driving method		Rack and pinion	
Torch adjustment:	Up / down	45 mm	
	Forward / backward	45 mm	
Torch holder diameter		16 ~ 20 mm	
Automatic stop function		Limit switch on each end of carriage	
Weaving unit WU-5R		-	Included
Welding method:	Continuous	Yes	Yes
	Tack / stitch	Yes	Yes
	Weaving / Oscillation	Optional	Standard
Power & signal cable		Power and signal cable integrated Y-branch cable (Carriage-branch: 6 m, branch-power: 10 m branch-feeder: 0.5 m)	
Torch holder diameter		16-20 mm	
Position adjustment by limit switch		Yes	
Encoder motor for precise speed control		Yes	
Digital display		Yes	
Crater fill function		Yes	
Input power		DC 24V	

Types	
Model	Stock #
IK-72W	90250
IK-72W Weaving	90251

Scope of delivery
Machine body
Power & signal cable
Rail mounting bracket for limit switch (2pcs)
Allen keys (2pcs)
Operation manual



## EMEA Sales and Service Offices

### FRANCE

KOIKE France S.A.R.L.  
ZAC de la Vallée de L'aunelle  
RN Cellules C1 à C4  
59144 Wargnies-Le-Grand  
T: +33 327304343

### GERMANY

KOIKE EUROPE B.V. Germany Branch Office  
Im Löchel 2  
35423 Lich-Eberstadt  
T: +49 6004916930

### ITALY

KOIKE ITALIA Srl  
Via Papa Giovanni XXIII, n 45  
20053 - Rodano (Milano)  
T: +39 0295328717

### UAE

KOIKE MIDDLE EAST FZE  
SAIF Zone Sharjah - UAE  
P.O. Box 122978  
T: +971 561177615

### THE NETHERLANDS

KOIKE EUROPE B.V.  
Grote Tocht 19  
1507 CG Zaandam

T: +31 (0)75 612 72 27  
F: +31 (0)75 612 34 61

info@koike-europe.com  
www.koike-europe.com