

Portable Automatic Welding Carriage for fillet welding



BUT01A05

WEL-HANDY MULTI NEXT TACK/STITCH OPERATION MANUAL



For every person who will be engaged in operation and maintenance supervision, It is recommended to read through this manual before any operations, so as to permit optimum operation of this machine.

KOIKE SANZO KOGYO CO.,LTD.

INTRODUCTION

Thank you very much for purchasing this product. Read this instruction manual thoroughly to ensure correct, safe and effective use of the machine.

Read the manual first to understand how to operate and maintain the machine. Cooperation between colleagues in the workplace is essential for safe, smooth operation.

Make sure you read, understand and take all the necessary safety precautions.













SAFETY PRECAUTIONS

This product is designed to be safe, but it can cause serious accidents if not operated correctly. Those who operate and repair this machine must read this manual thoroughly before operating, inspecting and maintaining the machine. Keep the manual near the machine so that anyone who operates the machine can refer to it if necessary.

- Do not use the machine carelessly without following the instructions in the manual.
- Do not use the machine until you have thoroughly understood the explanations in the manual.
- For safety, leave the installation, maintenance, inspection, and repair of the machine to a trained person who has thorough knowledge about welding machines or to a qualified operator.
- For safety, leave the operation of the machine to a person with complete knowledge of the instruction manual and sufficient skill.
- For safety education, make use of respective lecture meetings sponsored by the Welding Society and Welding Association, as well as by headquarters and branches of related scientific societies and associations. Make use of qualification tests for welding engineers and welding technicians as well.
- After reading the manual, keep it together with the warranty within reach of people concerned. Read the manual again as necessary.
- Contact our dealers or our branch office, sales office, or local office for any obscure points.
- When this manual is lost or damaged, place an order promptly with our dealer for another copy.
- When transferring the machine, be sure to attach the instruction manual to the machine to transfer it to the next owner.

QUALIFICATIONS FOR MACHINE OPERATOR

Operators and repair staff of this machine must completely understand the contents of the instruction manual and they must be qualified and educated to handle this equipment.

Symbol	Title	Meaning
	General	General caution, warning, and danger.
	Be careful not to get your fingers caught.	Possible injury to fingers if caught in the insertion part.
	Caution: Electric shock!	Possible electric shock under special conditions.
	Ground this equipment.	Operators must ground the equipment using the safety grounding terminal.
	Pull out the power plug from the outlet.	Operators must unplug the power plug from the outlet when a failure occurs or when there is a danger of lightning.
	Caution against bursting	Possible bursting under certain conditions.
	General	General warning.
	Caution: Hot!	Possible injury due to high temperature under certain conditions.
	Caution: Ignition!	Possible ignition under certain conditions.
	Caution: Magnet	Generating a magnetic field and magnetic waves.
	Wear light shielding goggles.	Be sure to wear light shielding goggle when looking at welding arcs.
	Wear dust/gas mask.	Wear a mask when dust, smoke, or gas is to be generated during work.
	Do not lift.	Lifting the carriage is prohibited to prevent an accident due to falling.



CONTENTS

1. Safety information-----	1
2. Safety precautions-----	2
3. Location of Safety labels -----	7
4. Features and specifications -----	8
4.1 Features -----	8
4.2 Configuration -----	8
4.3 Specification -----	9
5. Method of operation -----	10
5.1 Name of each part-----	11
5.2 Operation panel -----	15
5.2.1 Explanation about operation Unit functions -----	16
5.2.2 Regarding SELECT SWITCH-----	18
5.2.3 Metric, Inch switch over method -----	26
5.2.4 Operation Pattern Diagram-----	27
5.2.5 Time chart -----	30
5.3 Preparation and procedure for welding-----	32
5.4 System connection diagram-----	35
5.5 Applicable welding machine and signal adaptor-----	35
5.6 Operational precautions-----	35
6. Maintenance -----	36
6.1 Maintenance and inspection -----	37
6.1.1 Daily inspection -----	37
6.1.2 Monthly inspection -----	37
6.2 Recommended spare parts-----	37
6.3 Trouble shooting -----	38
6.4 Warranty -----	42
7. Wiring diagram-----	42
8. Assembly drawing of WEL-HANDY MULTI NEXT TACK/STITCH-----	43
9. Parts list -----	44
9.1 Main body and inside parts -----	44
9.2 Outside parts-----	46
9.3 Electrical parts-----	48
10. Inquiry counter-----	50

1 Safety information

Most accidents are caused by negligence of basic safety regulations during operation, inspection, and maintenance. Carefully read, understand, and master the safety precautions and preventive measures written in this manual or on the machine before operation, inspection, and maintenance of the machine.

- Carefully read this manual before use.
- Conduct installation of motive power source on the primary side, select the location of installation, store high-pressure gas, install pipes, store products after welding, and dispose of waste in conformity with laws and your in-house regulations.
- Precautions are provided in this manual for safe operation of the machine and prevention of injury to you or other people or other damage.
- Improper handling of the machine will cause injury or damage at various levels. The levels are classified into three categories, which are represented by respective caution symbols and signal terms to call people's attention. These symbols and terms are used in the same way on the warning labels stuck to the machine.

Caution symbol	Signal terms	Definition of terms
	DANGER	Improper handling is very likely to cause death or serious injury.
	WARNING	Improper handling can cause death or serious injury.
	CAUTION	Improper handling can cause injury or physical damage. It is also used to point out dangerous habitual action.
	Notice sign	The notice sign notifies machine operators and maintenance men of precautions as to parts of the machine or peripheral equipment that will lead to breakdown.

The serious injury mentioned above refers to loss of eyesight, injury, burns (high/medium temperature), electric shock, bone fracture, poisoning which leave an aftereffect or require hospitalization or regular treatment at a hospital for an extended period of time. The injury refers to a wound, burn, or electric shock which do not need hospitalization or regular treatment at a hospital for an extended period of time. The physical damage refers to damage to assets and extensive loss due to damage to the machine.

2 Safety precautions



WARNING

Strictly observe the following to prevent accidents resulting in serious injury or death.

- This welding machine is designed and manufactured by taking safety into consideration. However, never fail to observe the warning and precautions described in this instruction manual, otherwise accidents leading to serious injury or death can result.
- Keep people out of the space around the welding machine and working area.
- The welding machine generates a magnetic field around itself. Such a magnetic field affects certain types of sensors and clocks. For the same reason, any person who have a pacemaker in his heart shall not approach the welding machine in operation or the welding space unless he has obtained doctor's permission.
- For safety, leave the installation, maintenance, inspection, and repair of the machine to a person who has thorough knowledge about welding machines or to a qualified operator.
- For safety, leave the operation of the machine to a person with complete knowledge of the instruction manual and sufficient skill.
- Do not use this machine for any purpose other than arc welding described in the instruction manual.
- Do not remodel the machine.
- Check the safety around the machine before operation to prevent accidents.
- Be sure to hold the handle when carrying the machine.
- Wear leather gauntlets when touching the machine during welding or right after operation.
Do not touch the welded surface until it has cooled.



WARNING

Strictly observe the following to prevent electric shock.



- Do not touch the charged section; otherwise fatal electric shock or burns can result. When the power on the input side is turned on, the input circuit and the inside of the welding machine are charged. Even if the input power is turned off, the capacitor may have been charged. When the welding power is output, the electrode and base metal, as well as the metal portion in contact with these, are charged.
- Never touch charged sections.
- The welding power supply case and base metal, as well as jigs electrically connected to them, shall be grounded in conformity with the law (Technical Standard for Electric Equipment) by a qualified electric engineer.
- Turn off all power supplies on the input side by means of switches in the switch boxes before installation, maintenance, and inspection. The capacitor will not discharge completely right after the input power is turned off. Check that no voltage is remaining before maintenance or inspection.
- Periodically conduct maintenance and inspection. Repair damaged parts before

resuming operation.

- Do not use cables with Insufficient capacity or damaged cables whose conductors are exposed.
- firmly tighten and insulate cable connections.
- Firmly connect the welding cable on the base metal side at a location as close as possible to the base metal.
- Do not use the machine with the welding machine case or coser removed.
- Be sure to cover the input and output terminals before use.
- Do not use broken or wet gauntlets.
- Never fail to use a life-line when working in high places.
- Turn off power switches of all devices and input-side power supply when the machine is not used.
- Do not wear wet clothes.
- Do not stand on or touch the wet floor.
- Do not use the machine outdoors when it is raining.
- Do not leave the machine outdoors after use.
- Be sure to install a fuse or breaker on the input power supply side.
- Check the supply voltage of the machine before use.
The tolerance for the input supply voltage is plus or minus 10% of the rating. Use of the machine out of the folerance is prohibited.
- The metal receptacle (plug) on the tough-rubber sheath cable is threaded. Tighten it firmly.
- Be sure to ground the tough-rubber sheath cable of the machine.
- Turn off the power and stop operation in the following cases, and ask an engineer with special knowledge of electricity to repair.
 - *Broken or worn-out cables
 - *Damage due to water leakage or other liquid
 - *Malfunction of the machine inspire of operation in conformity with the instruction manual.
 - *Breakdown of the machine.
 - *Abnormal performance of the machine which requires tune-up.
- Ask an engineer with expertise to maintain, inspect, or repair the machire.
- Please make sure that any foreign material does not attach to the connector of the machine nor to the plug of the power cable when the plug of the power cable is connected to the machine.
Foreign materials can cause short-circuits or melt the connector.



CAUTION

Use protective gear to protect you and others from arc light, scattered spatters/slugs, and noise.



- The arc light includes harmful ultraviolet rays and infrared rays, causing Inflammation of eyes or burns.
- Scattered spatters and slugs can damage your eyes and cause burns.
- Noise can cause hearing difficulties.
- Wear light-shielding goggles or hand shield, which blocks light sufficiently, for welding operation or monitoring welding.
- Wear protective goggles to protect your eyes from spatters and slugs.
- Install a protective curtain around the welding site so that arc light will not reach the eyes of people around the site.
- Wear protective gear such as leather gauntlets. clothes with long-sleeves, leg cover, leather apron, helmet, and safety shoes.
- When the noise level is high, wear a noise-proofing protector.

**CAUTION**

Use protective gear to protect you and others from fumes and gas generated by welding.



- Welding generates fumes and gas. Inhalation of such fumes and gas can damage your health.
- Welding operation in a small space causes deficiency of oxygen, which is very likely to cause suffocation.
- To prevent gas poisoning and suffocation, use the local waste disposal facilities stipulated by the law (Industrial Safety and Health Law and Regulations to Prevent Damage due to Dust) or use an effective inhaler.
- When the welding space is small, ventilate the space sufficiently or wear an inhaler. Have a trained watchman monitor welding.
- Welding operation near places where degreasing, washing, or spraying is conducted may lead to generation of harmful gas. Do not conduct welding near such places.
- Welding zinc plated steel sheets or other coated steel sheets will generate harmful fumes. Remove the coating before welding, or wear an inhaler before operation.

**CAUTION**

Strictly observe the following to prevent gas cylinders from falling or bursting.



- Gas cylinders, when they fall, can cause accidents leading to death or injury.
- High-pressure gas is contained in gas cylinders. Improper handling of gas cylinders can cause a burst or emission of high-pressure gas, causing accidents that lead to death or injury.
- Handle gas cylinders in conformity with the law (High Pressure Gas Control Law).
- Do not expose gas cylinders to high temperatures.
- Set gas cylinders in a special cylinder stands to prevent the gas cylinders from falling.
- Never generate arcs on gas cylinders. Do not hook the welding torch on gas cylinders, or do not allow electrode to touch gas cylinders.
- Do not bring your head close to the discharge port when opening the valve on the gas cylinder.
- Attach a protective cap to gas cylinders when they are kept unused.
- Use a gas flow rate controller made or recommended by a welding machine manufacture.
- Read the instruction manual for the gas flow rate controller before use, and strictly observe the precautions.
- Never use a gas cylinder from which gas is leaking or a broken gas cylinder.
- Use gas cylinders only for specified purposes.
- DO not apply oil or grease to the valve on gas cylinders.
- When the valve on gas cylinders is hard to open, contact the dealer.

**CAUTION**

Strictly observe the following to prevent injury due to rotary section.



- Do not bring your hands, hair, or clothes close to the cooling fan of the welding power supply or the feeder roller of the wire feeder; otherwise you can be caught in them.
- Do not bring your head near the end of the welding torch during wire inching; otherwise the wire may stick in your eyes.
- When the spool of wire is released, you can get hurt.
- Do not use the welding machine with its case or cover removed.
- Ask a trained person who has thorough knowledge of welding machines or a qualified person to remove the case for maintenance, inspection, or repair. Install a protective fence around the welding machine to prevent people from getting near carelessly.
- DO not bring your hand, fingers, hair, or clothes close to the rotating cooling fan or the roller of the feeder.
- Do not bring your head near the end of the welding torch during wire inching.
- Secure the end of the wire with the wire stopper on the spool when storing or moving the spool of wire or when setting it in the wire feeder.
- When inserting the spool of wire into the wire guide on the wire feeder, firmly hold the wire so that it will not be released.

**CAUTION**

Strictly observe the following to prevent fire, explosion, or burst.



- Spatters and hot base metal right after welding can cause fire.
- Imperfect connection of cables or imperfect contact on the route of the electric current on the steel bar and other base metal can cause fire because of heating due to resistance.
- Arcs generated on the container of gasoline or other inflammables can cause explosion.
- welding of sealed tanks or pipes can cause bursts.
- Do not do welding in a place where scattered spatters will be in contact with inflammables.
- Do not do welding in a place near inflammable gas.
- Do not bring hot base metal right after welding close to inflammables.
- Welding on ceilings, floors, and walls may cause fire on the hidden side. Remove inflammables from the hidden side.
- Firmly tighten cable connections, and firmly connect the welding cable on the base metal side at a location as close as possible to the base metal.
- Do not weld gas pipes filled with gas.
- Do not weld sealed tanks or pipes.
- Provide a fire extinguisher near the welding place to prepare for the worst.
- Do not weld a container that has inflammables inside.
- Do not have a lighter, matches, or other inflammables with you during welding.

About the transport of the machine

1. Be sure to hold the handle when carrying the machine.
2. Do not lift the carriage by holding its Handle. There is risk of falling off carriage while holding carriage by handle, if there is shock/impact at carriage or if mounting screw of handle is loose.

Machine noise

1. Volume of at the time of driving the machine is less than 70dB.

About external environment

1. Never use the machine outdoors when the weather is wet. This will cause failure of the machine and could cause a fatal accident by electric shock.
2. Please avoid high temperature and humidity.
3. Please use in an environment where the internal temperature is 5 ~ 70 °C.
4. Please use in an environment with internal humidity of 20 to 80% RH.

3 Location of Safety labels

Safety labels and labels for correct operations are stuck to the machine.

- Carefully read labels before operation and follow the instructions decried on them.
- Never peel off the labels. Keep them clean and legible at all times.

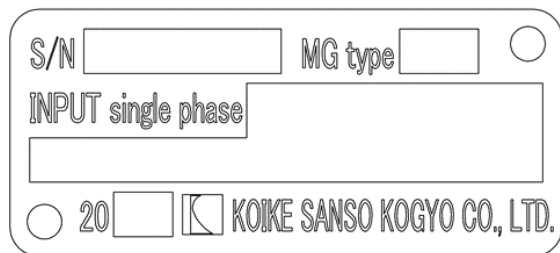
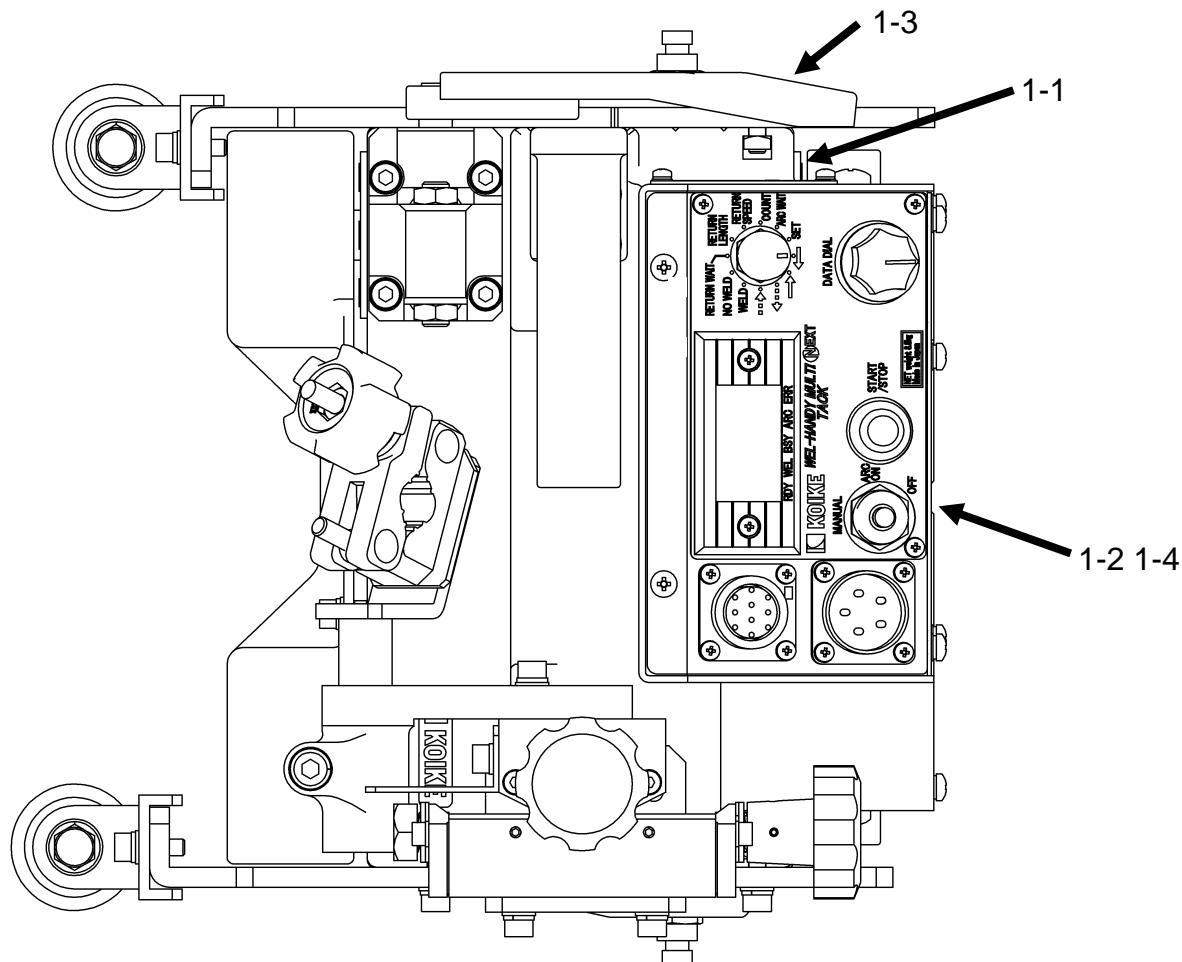

1-1

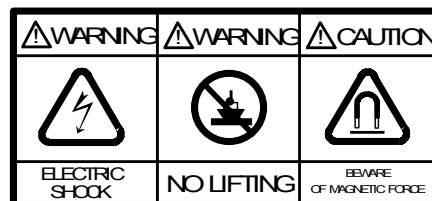

1-2

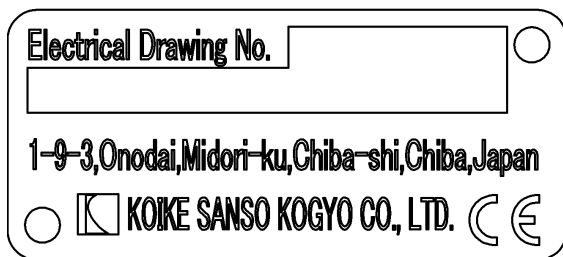

1-4



1-3

4 Features and specifications

4.1 Features

The WEL-HANDY MULTI NEXT TACK/STITCH has been developed to allow even unskilled operators to successfully do horizontal fillet welding (bottom steel plate traveling type) in a simple manner. Major features are as follows:

1. Compact, Light weight, Durable and Low gravity.
2. The powerful magnet has dramatically enhanced the tracing reliability and tractive force, thereby ensuring stable traveling.
3. It is able to operate plural machine by improved tracing reliability and automatic stopping function.
4. Continuous welding and Tack/Stitch welding operation is possible. but, its enables weaving welding by mounting a weaving unit WU -3R (sold separately) option parts. For more details, Refer the separate "weaving unit WU -3R instruction manual"
5. During the in Tack/Stitch running of the carriage distance, free running distance and welding return distance can be easily change.
6. According to setting function of number of welding, running and welding has been stop automatically after setting number of welding.
7. Motor with encoder is installed and actual speed is displayed on digital meter.
8. By pressing the Limit switch while stopping of carriage, carriage moves at constant speed and it becomes easy to align.
9. The roller arm is possible the change of taking in and out with one-touch operation due to the fixation ceremony by the screw.
10. The height of the guide rollers can be widely adjusted.
11. The structure of the driving portion is newly developed, has been improved endurance performance.
12. New magnet up / down mechanism was developed, magnet desorption became possible with a light force, maintainability was improved.
13. It is equipped with an overload detective function of the motor, to minimize the damage to the work caused by continuing the welding of the steel plate, when this carriage is stopped by the load from outside in any case.

The above features are expected to exhibit their effects in terms of "welding efficiency" and "operation by unskilled workers."



4.2 Configuration

1. Main unit	1set
2. Accessories	
*Hexagon wrench (M6/M5)	1pc each
Instruction manual	1pc



4.3 Specification

Item	Specifications
Model	WEL-HANDY MULTI NEXT TACK/STITCH
Applied position	Horizontal fillet
Profiling method	Stand plate press method
Driving method	Rubber roller 4 wheeler driving (permanent magnet absorption type) (Lower plate traveling system, traveling surface is steel plate)
Weight of carriage main body	8.8kg / 19.4lb
Traction force	15kg / 33.07lb
Dimension	L280 × W280×H255~300mm / L11.0 × W11.0 × H10.0inch
Torch adjustable range	Horizontal angle:40~55° Swept forward angle/sweep back angle : 5° Up and down:50mm/1.97inch Back and forth:50mm/1.97inch
Welding reserve	Total start and end : About 277mm/10.9inch
Control source	DC24V
Traveling speed	50~1500mm/min / 2.0~59.0inch/min
Welding distance	1~999.9 mm / 0.1~39.4inch ※Continuous welding is enabling in a continuously running mode.
Overhead distance	0~999.9mm / 0~39.4inch
Waiting time for return welding	0~999.9s
Return welding distance	0~999.9mm / 0~39.4inch
Return welding speed	50~1500mm/min / 2.0~59.0inch/min
Welding Number of times ※Tack/Stitch welding time	0~9999 Times
Ark stability time	0~10.0s
Electric power supply and interlock	Torch switch signal (connected to wire supply device) (A contact output of Self-holding type Relay)
Operation switch (operation panel)	SELECT SWITCH, DATA DIAL, Digital Meter, START/STOP button, Arc mode changing over switch (MANUAL, ARC ON,ARC OFF)
Traceable range	Gentle curve line (more than 5m/16.4feet radius)
Weaving machine (Option)	It is possible to mount the weaving unit WU-3R of optional part.

5 Method of operation

 <p>WARNING</p>	<p>Kindly take care about following things to avoid getting an electric shock.</p>
	<ul style="list-style-type: none"> ● Kindly remove input plug from outlet while checking, dis-assembling or repairing and turn OFF the control source while leaving. If it is necessary to carry out checking in the energized state, professional engineer having enough knowledge and skill about electric handling should go since there is risk of short circuit, getting electric shock.
<ul style="list-style-type: none"> ● Do not use welding equipment without case or cover. ● Kindly use power outlet with earth pin outlet since input plug has earth pin. It is connected to main body of carriage in operation panel. ● Kindly use input voltage within $\pm 10\%$ for power supply input to input plug. There is risk of short circuit due to failure of printed board on operation panel. ● In case of crack in insulation cover of power cable and torch cable, do not expose it to high temperature. There is risk of short circuit due to tearing of insulation covering. ● Kindly weld below the rated current and usage rate of torch to prevent dielectric breakdown due to overheating. ● Kindly place power cable and torch cable in proper manner so that they are not stretched or pulled. There is possibility of breakage of insulation by damaging holding part and connector part due to pulling. ● Do not throw or drop main body of carriage. There is risk of damaging insulation by breaking. ● While connecting to power cable plug to main body, kindly connect after verifying that foreign object is not touching to connector of main body, power cable plug. There is risk of connector erosion due to short circuit by foreign object. 	

 <p>WARNING</p>	<p>Strictly observe the following to prevent burns.</p>
<ul style="list-style-type: none"> ■ Never directly touch the torch nozzle, tip, orifice, insulation cylinder, and the surface of the carriage which are very hot right after welding. 	

 <p>WARNING</p>	<p>Kindly take care about following things to avoid falling off of carriage</p>
	<ul style="list-style-type: none"> ● Do not lift the carriage by holding its Handle. There is risk of falling off carriage while holding carriage by handle, if there is shock impact at carriage or if mounting screw of handle is loose.

5.1 Name of each part

Main unit of welding carriage

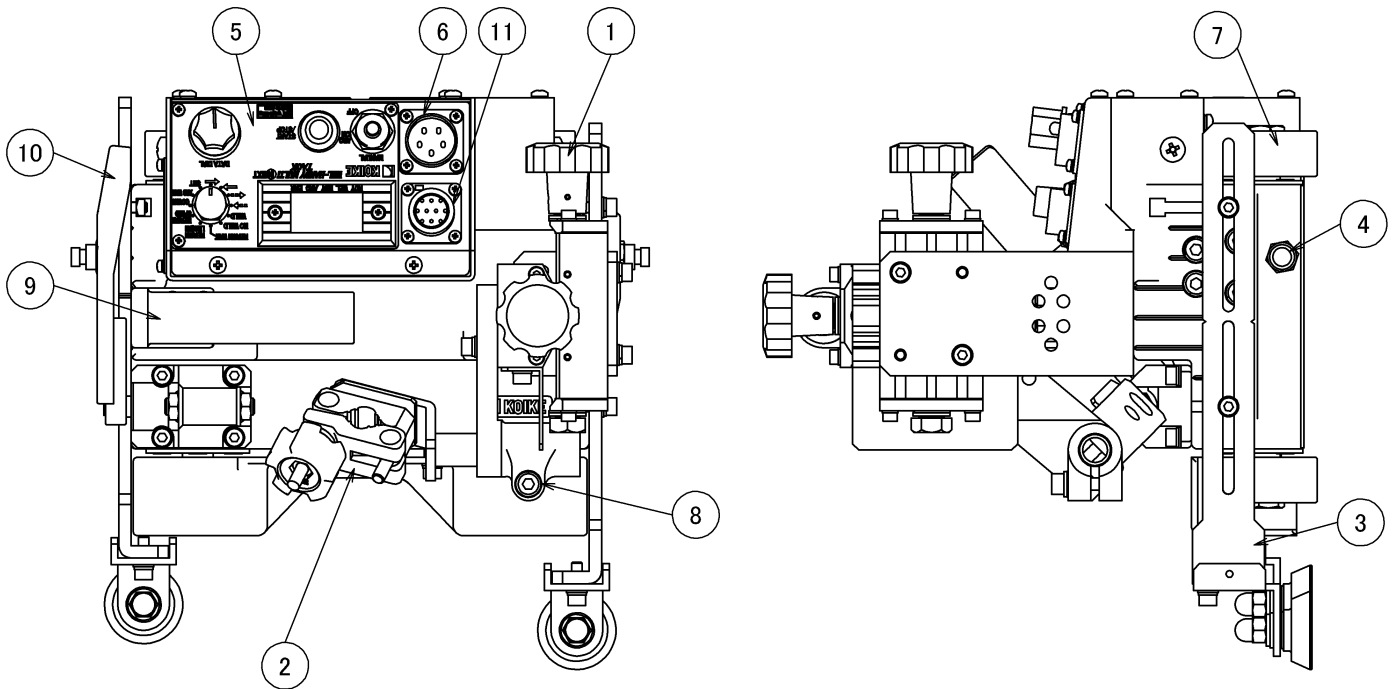



Fig.1 Name of each part

(1) Slide unit assembly

The arc point can be adjusted toward UP/DOWN or FRONT/REAR.
The each stroke is 50 mm / 1.97 inch.

(2) Torch holder

Insert the exclusive use torch mounting section into the torch holder to secure it

 WARNING	<p>Secure the insulated section of the torch when mounting it.</p>
	<p>■ When the conductive section is secured, a short circuit and/or electric shock can result.</p>

(3) Guide roller and arm

Press them against the vertical plate for welding by tracing.

Kindly fit doorway of Guide Roller Arm as shown in Figure 2.

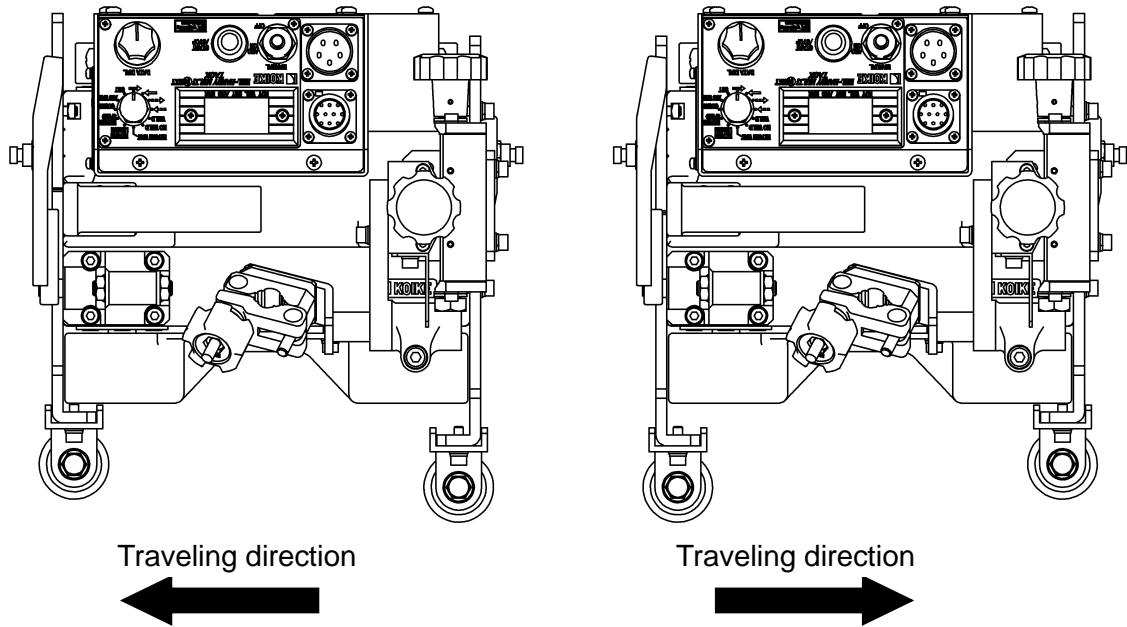

Fig.2 Doorway of Guide Roller Arm

The height of the guide rollers can be adjusted by changing the attaching method

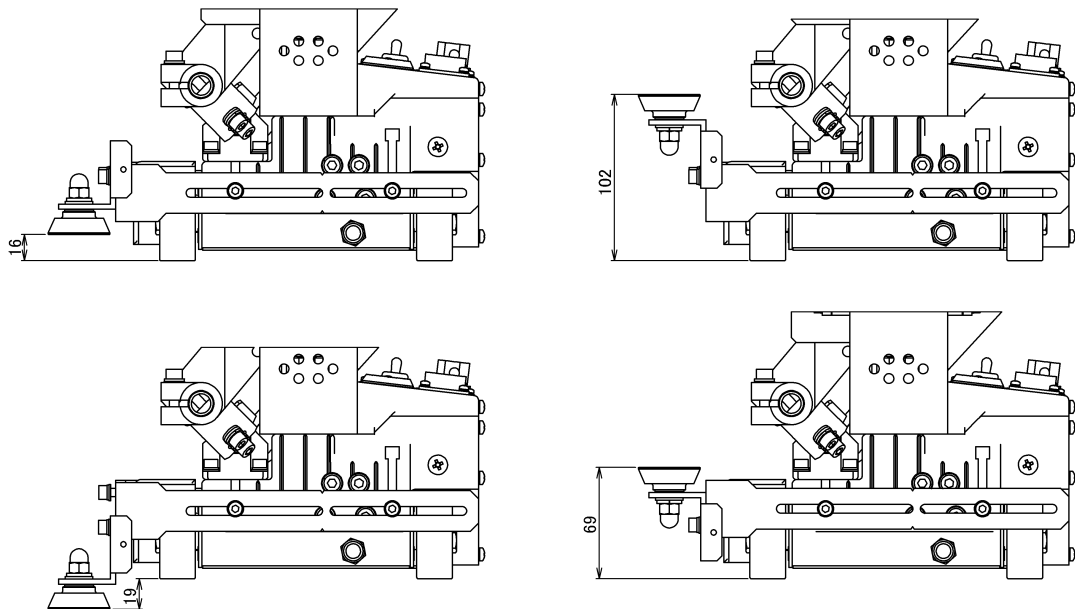



Fig.3 Height of guide roller

16mm	=0.630inch
19mm	=0.748inch
67mm	=2.638inch
102mm	=4.016inch

(4) Limit switch (“Fine tuning button for positioning” at the time of stopping of carriage)

By pressing Limit switch at the time of stopping of carriage, carriage moves towards opposite direction of pressed Limit switch only while switch is in pressed state. Kindly use it while fine tuning movement at the time of positioning of carriage.

 CAUTION	Do not apply impact to the Limit switch.
<p>■When impact is applied to the limit switch, it can be broken. When the limit switch is broken, the automatic stopping function will not work, and arcs and the traveling carriage will not stop.</p>	



(5) Operation panel

The detail is shown below.

(6) Receptacle

Kindly connect power cable to this receptacle.

The cable is connected between the control panel and the wire feeder, as well as power supply. (The cable is divided in the middle into one for the wire feeder and another for the input power.)

 WARNING	Never fail to ground the clip.
	<p>■Do not lift carriage by holding its Handle. There is risk of falling off carriage while holding the carriage by handle, if there is shock impact to carriage or if mounting screw of handle is loose.</p>

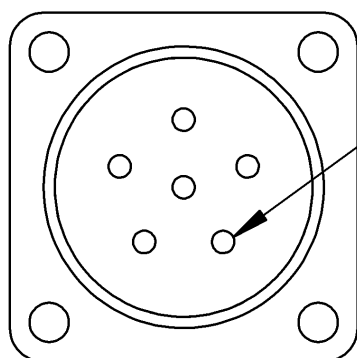

Ground wire position(No.3)



(7) Driving wheel (Rubber roller)

(8) Torch angle adjusting bolt

Used to set the torch angle. Loosen the bolt and swing the torch for setting within the range of 40-55 degrees.

(9) Handle

It is knob/grip used while transporting carriage.
 If mounting screws of knob are removed, 90° direction of knob can be changed.

 WARNING	<p>Do not lift carriage by holding handle</p>
	<p>■ Do not lift carriage by holding its Handle. There is risk of falling off carriage while holding the carriage by handle, if there is shock impact to carriage or if mounting screw of handle is loose.</p>

(10) Magnet lever

It can be used for magnet ON/OFF.
 The upper position is magnet OFF
 and the lower position is magnet ON.

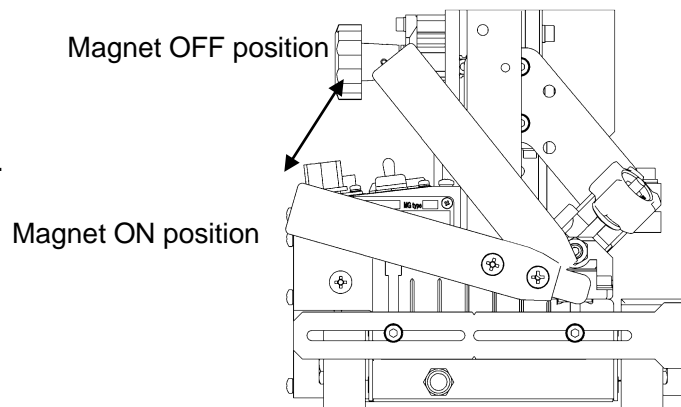



Fig4 Magnet lever

 CAUTION	<p>There is the possibility that the magnet absorbs automatically.</p>
<p>■ There is the possibility that the magnet absorbs automatically when it set it to the steel plate. Please pay attention because there is the possibility that the magnet lever works and insert the hand and clothes.</p>	



(11) Holder for Welding Unit WU-3R

It becomes holder for connecting optional weaving unit WU-3R. According to WU-3R, insert the metal plug.
 Refer the volume that how to use method of WU-3R (Weaving unit WU-3R instruction manual).

 CAUTION	<p>In case if you get connected WU-3R, make sure to Turn Off the Power.</p>
<p>■ When the power is on if it gets connected there is a possibility of failure.</p>	

5.2 Operation panel

V4.01/V4.02

 WARNING	<p>Kindly take care about following things to avoid getting an electric shock.</p>
	<p>■ Kindly remove input plug from outlet while checking, dis-assembling or repairing and turn OFF the control source while leaving. If it is necessary to carry out checking in the energized state, professional engineer having enough knowledge and skill about electric handling should go since there is risk of short circuit, getting electric shock.</p>
<p>■ Do not use welding equipment without case or cover.</p> <p>■ Please use input plug with ground connection possible, ground connection. It connects with the carriage body inside the operation panel.</p> <p>■ Kindly use input voltage within $\pm 10\%$ for power supply input to input plug. There is risk of short circuit due to failure of printed board on operation panel.</p> <p>■ In case of crack in insulation cover of power cable and torch cable, do not expose it to high temperature. There is risk of short circuit due to tearing of insulation covering.</p> <p>■ Kindly place power cable and torch cable in proper manner so that they are not stretched or pulled. There is possibility of breakage of insulation by damaging holding part and connector part due to pulling.</p> <p>■ Never fail to turn OFF the power switch (1) before attaching or detaching the receptacle.</p> <p>■ When you remove the plug, put rubber cap on the receptacle to prevent dust and dirt.</p> <p>■ When you found dust and dirt in the receptacle, remove these before connecting electric power cable plug.</p>	

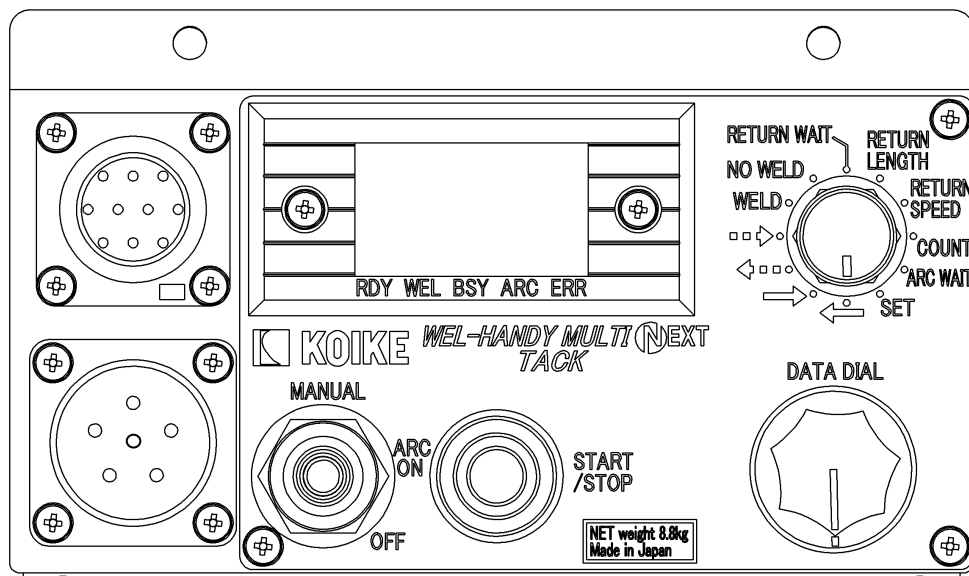
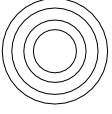

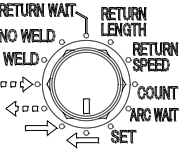

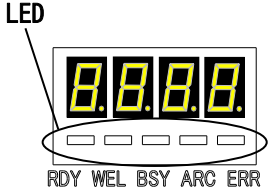

Fig 5 Operation panel

5.2.1 Explanation about operation Unit functions

Display	Name	Function
 <p>START/STOP</p>	<p>START/STOP Button</p>	<p>It is used at the time of start/stop of travelling of carriage. Moreover, there are cases where this function is used to set parameters ※When an error occurs, the error display is reset when you press the START / STOP switch . However , error if there is still cause of the error occurs again . Check each error Solution , please remove the cause .</p>
 <p>MANUAL ARC ON OFF</p>	<p>Arc changing over switch</p>	<p>There can be 3 modes of changing over in 3 point changing over switch as shown below. MANUAL : Kindly use it in wire inching and arc test. Wire comes out only while switch is on MANUAL. ※ Kindly take care as Arc is generated if torch end is touching welding material. ARC ON : Kindly use this position in normal welding operation. carriage starts traveling automatically after start of welding by pressing START/STOP button. ARC OFF : Only traveling of carriage is possible without welding operation by pressing START/STOP button at this position. Further it is used to change welding distance, preliminary feeding distance, welding return distance during traveling of Tack/Stitch carriage</p> <div style="border: 1px solid black; padding: 5px;"> <p> Caution Please do not press the START / STOP button while you are down to MANUAL side .</p> </div> <div style="border: 1px solid black; padding: 5px; margin-top: 5px;"> <ul style="list-style-type: none"> •Press the START / STOP button while you are down to MANUAL side , and back to the ARC ON continues to output the arc signal , and then traveling trolley and to ARC OFF. Again , the running of the arc output and the truck and press the START / STOP button will stop . Please be when subjected to the above-mentioned operation and restart to turn OFF the power once . </div>
 <p>RETURN WAIT RETURN LENGTH RETURN SPEED COUNT ARG WAIT SET NO WELD WELD</p>	<p>SELECT SWITCH</p>	<p>It is used for selecting each parameter and traveling mode. Kindly verify 5.2.2 Regarding SELECT SWITCH for each parameter.</p>
 <p>DATA DIAL</p>	<p>DATA DIAL</p>	<p>It is used in setting carriage travelling speed and each parameter. It increases the value at clockwise rotation and decreases at anti-clockwise rotation. Moreover, it outgrows increase/decrease of value at swift rotation.</p>
 <p>LED RDY WEL BSY ARC ERR</p>	<p>Digital Meter</p>	<p>It displays carriage travelling speed or value of each parameter. Operation status of carriage can be known from LED display of digital meter. RDY : It turns ON when electric supply of carriage is ON. WEL : It turns ON when welding signal is displayed while carriage is travelling. BSY : It turns ON during carriage is operating regardless of display/non display of welding signal. ARC : It turns ON at option of MANUAL, ARCON in (5) arc mode changing over switch. ERR : It turns ON at generation of operation error. At this time corresponding error number of error content is displayed on digital display</p>

<About error numbers> Error indications are three-digit numbers that start with "E.". Example indication **E010**







Error number	Error details	Cause	Corrective action
001	Link unit configuration failure error	There may be a contact failure in the wiring between electrical boards (connector numbers CN2, 3 for all boards in common, connector numbers CN4, 5 for the L-DSP display board).	Check for cable disconnections, and for contact failures of connectors and crimp-type terminals. (The LEDs on each board will flash when the power is turned on: if the LEDs do not flash or light, the circuit board may be faulty.)
002	Power failure detection error	This is an error that occurs on other equipment.	In the event that it is displayed, contact the distributor where you purchased this product or our sales office.
003	Inverter error		
004	Emergency stop error		
005	3-phase power supply error		
006	Breaker OFF error		
007	Encoder line connection error	The encoder line may be connected to MD-CN10 on the L-MD-A board.	Connect the encoder line to MD-CN5.
008	Motor deviation error	There may be a contact failure on the motor line or the encoder line.	Check for disconnections in all wires, and for contact failures of connectors and crimp-type terminals. Connect the motor line to MD-CN4, and the encoder line to MD-CN5, on the L-MD-A board.
010	Welding current detection signal ON timeout (5 seconds) error	This is an error that occurs on other equipment.	In the event that it is displayed, contact the distributor where you purchased this product or our sales office.
011	Signal logic inversion error while detecting welding current		
012	Encoder selection error		
013	Unit configuration unsuitable error		
014	Weld movement distance during tack operation error	Welding distance setting is 0.	Please set the welding distance setting to 1 mm or more.
016	Servo driver error	This is an error that occurs on other equipment.	In the event that it is displayed, contact the distributor where you purchased this product or our sales office.
017	Copying signal error		
018	Thermal guard error		
019	Thermal guard error		
020	Link unit configuration failure error		
021	X-axis-direction derailing error		
022	Y-axis-direction derailing error		
023	Z-axis-direction derailing error		
024	Motor overload error (encoder equipped)	An abnormal load may be being applied to the drive section or motor.	Remove any abnormal load from the drive section or motor.
025	Carriage backup error (Parameter)	It is possible that the power was turned off during carriage operation or fine adjustment movement by limit switch, and the backup was not implemented correctly.	Turn the power off and back on again. If the error display indication is not cleared after repeating the above several times, replace all the circuit boards being used.
026	Carriage backup error (System Parameters)		
125	WU-5R backup error (parameter)	This is an error that occurs on other equipment.	In the event that it is displayed, contact the distributor where you purchased this product or our sales office.
126	WU-5R backup error (System Parameters)		





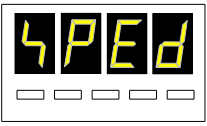

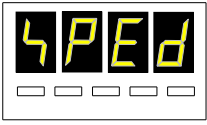
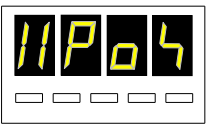

※ To recover from an error, unplug the power cable from the operation panel, turn off the power supply, check the corrective action described above, plug the power cable back into the operation panel and turn the power back on.

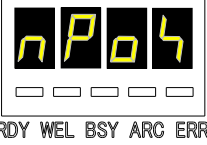







※ When an error occurs, the error indication is reset by pressing the START/STOP button, but eliminate the cause by referring to the corrective action described above before pressing the button.

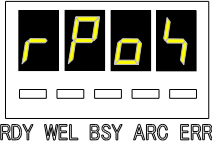

5.2.2 Regarding SELECT SWITCH

In WEL-HANDY MULTI NEXT TACK/STITCH, it is possible to carry out continuous welding and TACK/STITCH welding operation by selecting each mode and each parameter by SELECT SWITCH Regarding each mode and each parameter it is given as below.

Operation unit display	Digital display	Setting range	Factory default
TRUCK SPEED  	 RDY WEL BSY ARC ERR	50~1500mm/min	—
		2.0~59.0inch/min	
		Function	
		<p>Continuous traveling mode It is used when carriage is to be run continuously. When this mode is selected, carriage starts traveling in the direction of directing arrow by pressing START/STOP button. It shows carriage traveling speed value during stop and traveling operation. It is possible to change carriage traveling speed by turning DATA DIAL during stop and traveling of carriage. Kindly turn DATA DIAL in clock wise direction to increase speed of carriage and in anti-clock wise direction to reduce speed.</p>	
TRUCK SPEED  	 RDY WEL BSY ARC ERR	50~1500mm/min	—
		2.0~59.0inch/min	
		Function	
		<p>TACK/STITCH traveling mode This mode is selected when carriage is to be TACK/STITCH traveled. When this mode is selected, carriage starts travelling in the direction of directing arrow by pressing START/STOP button. It shows carriage traveling speed value during stop and traveling operation. It is possible to change carriage traveling speed by turning DATA DIAL during stop and traveling of carriage. Kindly turn DATA DIAL in clock wise direction to increase speed of carriage and in anti-clock wise direction to reduce speed.</p>	
WELD	 RDY WEL BSY ARC ERR	1~999.9mm	20.0mm
		0.1~39.4inch	0.8inch
		Function	
		<p>Welding distance setting(It shows length of the portion to be weld) This mode is selected to set welding distance at the time of TACK/STITCH travelling mode. It displays welding distance value at stopping of carriage on the digital meter. It is possible to change the welding distance at TACK/STITCH welding by turning DATA DIAL while carriage is stopped. It is possible to change welding distance during TACK/STITCH traveling by matching SELECT SWITCH to WELD or by Arc changing over switch operation.(Kindly refer to page no.22 for change method details)</p>	
 CAUTION		When it is set to 0mm, it displays error and it is not possible to operate. Kindly operate by setting at more than 1mm or 0.1inch .	

Operation unit display	Digital display	Setting range	Factory default										
NO WELD		0~999.9mm	20.0mm										
		0.1~39.4inch	0.8inch										
		Function											
		<p>Preliminary feeding distance settings (It shows length of the portion not to be weld)</p> <p>This mode is selected to set preliminary feeding distance at the time of TACK/STITCH travelling mode.</p> <p>It displays preliminary feeding distance value on the digital meter at stopping of carriage.</p> <p>It is possible to change the preliminary feeding distance at TACK/STITCH welding by turning DATA DIAL while carriage is stopped.</p> <p>It is possible to change preliminary feeding distance during carriage travelling by matching SELECT SWITCH to NO WELD or by Arc changing over switch operation.(Kindly refer to page no.22 for change method details)</p> <p>Kindly always keep the carriage maximum speed of travelling during preliminary feeding distance as (1500mm/min or 59.0inch/min).</p>											
RETURN WAIT		0~999.9s	0.0s										
		Function											
		<p>Welding return waiting time setting (It shows welded time at stop state while ARC is ON after completion of welding)</p> <p>This mode is selected to set welding return waiting time at the time of continuous travelling mode and TACK/STITCH travelling mode.</p> <p>It displays welding return waiting time value while stopping on the digital meter.</p> <p>It is possible to change the welding return waiting time by turning DATA DIAL during stopping of carriage.</p> <p>Welding return waiting time can be changed if SELECT SWITCH is matched with RETURN WAIT during carriage is travelling.</p> <p>※The welding current during the welding return waiting time varies depending on the crater filling (self-latching) ON/OFF setting.</p> <table border="1" style="width: 100%; border-collapse: collapse;"> <tr> <td style="width: 50%;">crater (self-latching)"ON"</td> <td style="width: 50%;">crater (self-latching)"OFF"</td> </tr> <tr> <td style="text-align: center;">Welding with crater current</td> <td style="text-align: center;">Welding with main current</td> </tr> </table>		crater (self-latching)"ON"	crater (self-latching)"OFF"	Welding with crater current	Welding with main current						
		crater (self-latching)"ON"	crater (self-latching)"OFF"										
Welding with crater current	Welding with main current												
<p>※Precautions on Use</p> <p>Be sure to make the crater filling (self-latching) setting at the welding power source and that at the carriage agree</p> <p>Set the crater filling (self-latching) switch of the welding power source according to the following table.</p> <p>Please set in “parameter setup mode No.0003” the setting method of the truck side.</p> <table border="1" style="width: 100%; border-collapse: collapse; text-align: center;"> <tr> <td style="width: 50%;">Welding power supply side</td> <td style="width: 10%;"></td> <td style="width: 40%;">carriage side</td> </tr> <tr> <td>crater (self-latching) "ON"</td> <td>↔</td> <td>-0.1 or 0.4~1.0</td> </tr> <tr> <td></td> <td>match</td> <td></td> </tr> <tr> <td>crater (self-latching) "OFF"</td> <td>↔</td> <td></td> </tr> </table>		Welding power supply side		carriage side	crater (self-latching) "ON"	↔	-0.1 or 0.4~1.0		match		crater (self-latching) "OFF"	↔	
Welding power supply side		carriage side											
crater (self-latching) "ON"	↔	-0.1 or 0.4~1.0											
	match												
crater (self-latching) "OFF"	↔												
<table border="1" style="width: 100%; border-collapse: collapse;"> <tr> <td style="width: 20%; text-align: center;"> CAUTION</td> <td>If the settings do not agree, the welding operation may not proceed as set. Be sure to make the crater filling (self-latching) settings agree.</td> </tr> </table>		 CAUTION	If the settings do not agree, the welding operation may not proceed as set. Be sure to make the crater filling (self-latching) settings agree.										
 CAUTION	If the settings do not agree, the welding operation may not proceed as set. Be sure to make the crater filling (self-latching) settings agree.												





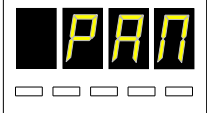
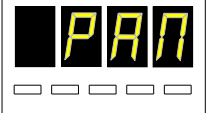
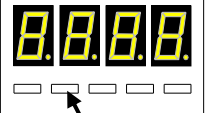



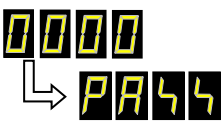
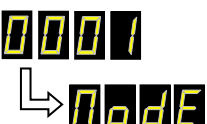
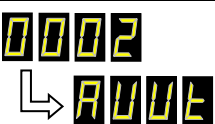
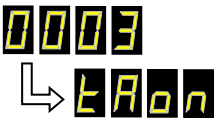





Operation unit display	Digital display	Setting range	Factory default												
RETURN LENGTH		0~999.9mm	0.0mm												
		0~39.4inch	0.0inch												
		Function													
		<p>Welding return distance settings(It shows length of the portion to be weld in the opposite direction while Arc is ON after welding completion)</p> <p>This mode is selected to set welding return distance at the time of continuous travelling mode and TACK/STITCH travelling mode.</p> <p>It operates after completion of welding return waiting time.</p> <p>It operates after completion of welding distance at welding return waiting time as 0s.</p> <p>It displays welding return distance value while stopping of carriage on digital meter.</p> <p>It is possible to change welding return distance by turning DATA DIAL during stopping of carriage.</p> <p>Welding return distance during carriage travelling can be changed by matching SELECT SWITCH to RETURN LENGTH or by Arc changing over switch operation.</p> <p>※The welding current during the welding return waiting time varies depending on the crater filling (self-latching) ON/OFF setting.</p>													
		<table border="1" style="width: 100%;"> <tr> <td>crater (self-latching)"ON"</td> <td>crater (self-latching)"OFF"</td> </tr> <tr> <td>Welding with crater current</td> <td>Welding with main current</td> </tr> </table>		crater (self-latching)"ON"	crater (self-latching)"OFF"	Welding with crater current	Welding with main current								
		crater (self-latching)"ON"	crater (self-latching)"OFF"												
		Welding with crater current	Welding with main current												
		<p>※Precautions on Use</p> <p>Be sure to make the crater filling (self-latching) setting at the welding power source and that at the carriage agree</p> <p>Set the crater filling (self-latching) switch of the welding power source according to the following table.</p> <p>Please set in “parameter setup mode No.0003” the setting method of the truck side.</p>													
		<table border="1" style="width: 100%; text-align: center;"> <tr> <td>Welding power supply side</td> <td></td> <td>carriage side</td> </tr> <tr> <td>crater (self-latching) "ON"</td> <td>↔</td> <td>-0.1 or 0.4~1.0</td> </tr> <tr> <td></td> <td>match</td> <td></td> </tr> <tr> <td>crater (self-latching) "OFF"</td> <td>↔</td> <td></td> </tr> </table>		Welding power supply side		carriage side	crater (self-latching) "ON"	↔	-0.1 or 0.4~1.0		match		crater (self-latching) "OFF"	↔	
		Welding power supply side		carriage side											
crater (self-latching) "ON"	↔	-0.1 or 0.4~1.0													
	match														
crater (self-latching) "OFF"	↔														
<table border="1" style="width: 100%;"> <tr> <td style="text-align: center;"></td> <td> <p>CAUTION</p> <p>If the settings do not agree, the welding operation may not proceed as set. Be sure to make the crater filling (self-latching) settings agree.</p> </td> </tr> </table>			<p>CAUTION</p> <p>If the settings do not agree, the welding operation may not proceed as set. Be sure to make the crater filling (self-latching) settings agree.</p>												
	<p>CAUTION</p> <p>If the settings do not agree, the welding operation may not proceed as set. Be sure to make the crater filling (self-latching) settings agree.</p>														
Operation unit display	Digital display	Setting range	Factory default												
RETURN SPEED		50~1500mm/min	50mm/min												
		2.0~59.0inch/min	2.0inch/min												
		Function													
		<p>Welding return speed settings(It shows travelling speed at the time of welding return distance)</p> <p>This mode is selected to set welding return travelling speed at the time of continuous travelling mode and TACK/STITCH travelling mode.</p> <p>It displays welding return speed value during stopping of carriage on digital meter.</p> <p>Further welding return speed can be changed by turning DATA DIAL during stopping</p>													









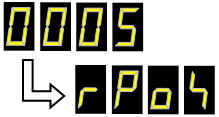

Operation unit display	Digital display	Setting range	Factory default
COUNT		0~9999 times	0 time
		Function	
		<p>Welding frequency settings</p> <p>It is welding frequency at the time of TACK/STITCH travelling mode. It displays welding frequency during stopping of carriage on digital meter. Welding frequency at the time of TACK/STITCH travelling by turning DATA DIAL only while stopping of carriage. (It is not possible to make changes while carriage is travelling) If welding frequency is set to 0, it continues with TACK/STITCH travelling till START/STOP button or Limit switch is pressed.</p>	
Operation unit display	Digital display	Setting range	Factory default
ARC WAIT		0~10.0s	0.5s
		Function	
		<p>Arc stability time setting (It shows time till start of travelling of carriage after Arc ON)</p> <p>This mode is selected to set Arc stability time at the time of continuous travelling mode and TACK/STITCH travelling mode. It is time till start of travelling of carriage by pressing START/STOP button. It carries out welding while carriage is in stop state during Arc stability time and countdowns digital meter time. It displays Arc stability time value on the digital meter while carriage is in stop state. Arc stability time can be changed by turning DATA DIAL only while carriage is in stop state.</p>	
 CAUTION		<p>Since welding is carried out in Arc stability time by initial Arc current, it is necessary to set initial Arc settings at welding current end. Though Arc stability time at carriage end is from start to last, it is from the time of pressing of START/STOP button (Arc signal ON) till travelling of carriage. Kindly verify operation manual of welding current for initial Arc setting.</p>	

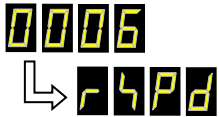
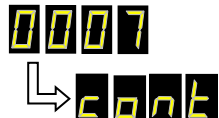

Operation unit display	Digital display	Setting range	Factory default
SET		0000~0011	—
		Function	
<p><u>Parameter setup mode</u> Each parameter can be set from this mode. ※ This mode can be operated only while carriage is in stop state. Details about parameter numbers are given below. ※ For more information please refer to each function of the SELECT SWICTH . For more information on the parameters number, please check <u>Parameter number details.</u></p> <p>1)Turn SELECT SWITCH and</p> <div style="display: flex; align-items: center;">  <div style="margin-left: 10px;"> <p>RDY WEL BSY ARC ERR and match it.</p> </div> </div> <p>2)Select the parameter number to be changed by turning DATA DIAL.</p> <p>3)Set by pressing START/STOP button.</p> <p>4)Edit by turning DATA DIAL. It turns ON WEL of LED during editing.</p> <div style="display: flex; align-items: center;">  <div style="margin-left: 10px;"> <p>Turn ON</p> </div> </div> <p>5)Set by pressing START/STOP button after completion of editing.</p> <p>※)While initializing, turn OFF electric supply for once after above mentioned operation, and turn ON the electric supply again and complete the operation.</p>			

Parameter number details

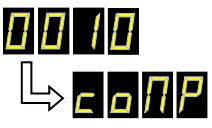
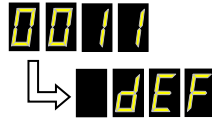

Parameter number	Explanation																		
	<p>Unintended input prevention setting Parameter editing is enabled when the value of this parameter is 0114 If it is any other value, input is possible only for this parameter. Use this to prevent unintended input. Setting range : 0000~9999 Factory default : 0114</p>																		
	<p>Additional Settings for the Travel Function Setting range : 0~7 Factory default : 0 Enable the addition of functions when the carriage is traveling. As the setting value, enter the sum of the values A for the individual items. Example: To turn B0 (value A = 1) and B2 (value A = 4) ON: Set value = 1 + 4 = 5</p> <table border="1"> <thead> <tr> <th rowspan="2"></th> <th rowspan="2">Explanation</th> <th colspan="2">A</th> </tr> <tr> <th>ON</th> <th></th> </tr> </thead> <tbody> <tr> <td>B0</td> <td>ON to automatically return to the welding start position when welding has finished. [Note] The fillet welding in copying operations causes a deviation with respect to the original position.</td> <td>1</td> <td>B0</td> </tr> <tr> <td>B1</td> <td>Processing when operation is stopped by the STOP switch during tack welding OFF : Start tack operation from the start ON : Continue tack operation from the point where it stopped Note that welding is performed from the next tack, not the portion where the stop occurred during welding.</td> <td>2</td> <td>B1</td> </tr> <tr> <td>B2</td> <td>Tack welding idling distance extension function OFF : Extended only while the arc selection switch is ON, extension stopped when it is OFF ON: Extension started the first time the arc selection switch is set to ON, extension stopped the second time it is set to ON (self-latching)</td> <td>4</td> <td>B2</td> </tr> </tbody> </table>		Explanation	A		ON		B0	ON to automatically return to the welding start position when welding has finished. [Note] The fillet welding in copying operations causes a deviation with respect to the original position.	1	B0	B1	Processing when operation is stopped by the STOP switch during tack welding OFF : Start tack operation from the start ON : Continue tack operation from the point where it stopped Note that welding is performed from the next tack, not the portion where the stop occurred during welding.	2	B1	B2	Tack welding idling distance extension function OFF : Extended only while the arc selection switch is ON, extension stopped when it is OFF ON: Extension started the first time the arc selection switch is set to ON, extension stopped the second time it is set to ON (self-latching)	4	B2
	Explanation			A															
		ON																	
B0	ON to automatically return to the welding start position when welding has finished. [Note] The fillet welding in copying operations causes a deviation with respect to the original position.	1	B0																
B1	Processing when operation is stopped by the STOP switch during tack welding OFF : Start tack operation from the start ON : Continue tack operation from the point where it stopped Note that welding is performed from the next tack, not the portion where the stop occurred during welding.	2	B1																
B2	Tack welding idling distance extension function OFF : Extended only while the arc selection switch is ON, extension stopped when it is OFF ON: Extension started the first time the arc selection switch is set to ON, extension stopped the second time it is set to ON (self-latching)	4	B2																
	<p>Arc stability waiting time settings Setting range : 0~10.0s Factory default : 0s ※ It can be also set in ARC WAIT OF SELECT SWICTH.</p>																		
	<p>Torch Switch ON Output Time Setting (Crater Filling) Setting range :-0.1~1.0s Factory default : 0 Set the ON time for torch switch output to the welding power source when welding starts.</p> <ul style="list-style-type: none"> • If the welding power source setting is self-latching OFF (crater filling not supported), set this parameter to 0. • Set this value to between 0.4 and 1.0 if the power supply setting is self-latching (crater filling supported). • If the value above is set and the arc is frequently interrupted, set the value to -0.1. In this case, the signal will remain in the ON state up until the arc stop timing. However, since the specifications of some welding power sources do not support the setting of -0.1, set the value to 1.0 and adjust. <p>※The welding current during the welding return waiting time varies depending on the crater filling (self-latching) ON/OFF setting..</p> <table border="1"> <tr> <td>crater (self-latching)"ON"</td> <td>crater (self-latching)"OFF"</td> </tr> <tr> <td>Welding with crater current</td> <td>Welding with main current</td> </tr> </table>	crater (self-latching)"ON"	crater (self-latching)"OFF"	Welding with crater current	Welding with main current														
crater (self-latching)"ON"	crater (self-latching)"OFF"																		
Welding with crater current	Welding with main current																		

	<p>※Precautions on Use</p> <p>Be sure to make the crater filling (self-latching) setting at the welding power source and that at the carriage agree</p> <p>Set the crater filling (self-latching) switch of the welding power source according to the following table.</p> <p>Please set in “parameter setup mode No.0003” the setting method of the truck side.</p> <table border="1" style="width: 100%; border-collapse: collapse; text-align: center;"> <tr> <td style="width: 50%;">Welding power supply side</td> <td style="width: 10%;"></td> <td style="width: 40%;">carriage side</td> </tr> <tr> <td>crater (self-latching) "ON"</td> <td>↔</td> <td>-0.1 or 0.4~1.0</td> </tr> <tr> <td></td> <td>match</td> <td></td> </tr> <tr> <td>crater (self-latching) "OFF"</td> <td>↔</td> <td></td> </tr> </table> <div style="border: 1px solid black; padding: 5px; margin-top: 10px;"> <table style="width: 100%;"> <tr> <td style="text-align: center; width: 20%;"> CAUTION</td> <td>If the settings do not agree, the welding operation may not proceed as set. Be sure to make the crater filling (self-latching) settings agree.</td> </tr> </table> </div>	Welding power supply side		carriage side	crater (self-latching) "ON"	↔	-0.1 or 0.4~1.0		match		crater (self-latching) "OFF"	↔		 CAUTION	If the settings do not agree, the welding operation may not proceed as set. Be sure to make the crater filling (self-latching) settings agree.				
Welding power supply side		carriage side																	
crater (self-latching) "ON"	↔	-0.1 or 0.4~1.0																	
	match																		
crater (self-latching) "OFF"	↔																		
 CAUTION	If the settings do not agree, the welding operation may not proceed as set. Be sure to make the crater filling (self-latching) settings agree.																		
<div style="text-align: center; margin-bottom: 5px;"></div> <div style="text-align: center;"></div>	<p>Welding return waiting time settings</p> <p>Setting range : 0~999.9s</p> <p>Factory default : 0s</p> <p>※ It can be also set in RETURN WAIT OF SELECT SWICTH.</p> <p>※The welding current during the welding return waiting time varies depending on the crater filling (self-latching) ON/OFF setting.</p> <table border="1" style="width: 100%; border-collapse: collapse; text-align: center;"> <tr> <td style="width: 50%;">crater (self-latching)"ON"</td> <td style="width: 50%;">crater (self-latching)"OFF"</td> </tr> <tr> <td>Welding with crater current</td> <td>Welding with main current</td> </tr> </table> <p>※Precautions on Use</p> <p>Be sure to make the crater filling (self-latching) setting at the welding power source and that at the carriage agree.</p> <p>Set the crater filling (self-latching) switch of the welding power source according to the following table.</p> <p>Please set in “parameter setup mode No.0003” the setting method of the truck side.</p> <table border="1" style="width: 100%; border-collapse: collapse; text-align: center;"> <tr> <td style="width: 50%;">Welding power supply side</td> <td style="width: 10%;"></td> <td style="width: 40%;">carriage side</td> </tr> <tr> <td>crater (self-holding) "ON"</td> <td>↔</td> <td>-0.1 or 0.4~1.0</td> </tr> <tr> <td></td> <td>match</td> <td></td> </tr> <tr> <td>crater (self-holding) "OFF"</td> <td>↔</td> <td></td> </tr> </table> <div style="border: 1px solid black; padding: 5px; margin-top: 10px;"> <table style="width: 100%;"> <tr> <td style="text-align: center; width: 20%;"> CAUTION</td> <td>If the settings do not agree, the welding operation may not proceed as set. Be sure to make the crater filling (self-latching) settings agree.</td> </tr> </table> </div>	crater (self-latching)"ON"	crater (self-latching)"OFF"	Welding with crater current	Welding with main current	Welding power supply side		carriage side	crater (self-holding) "ON"	↔	-0.1 or 0.4~1.0		match		crater (self-holding) "OFF"	↔		 CAUTION	If the settings do not agree, the welding operation may not proceed as set. Be sure to make the crater filling (self-latching) settings agree.
crater (self-latching)"ON"	crater (self-latching)"OFF"																		
Welding with crater current	Welding with main current																		
Welding power supply side		carriage side																	
crater (self-holding) "ON"	↔	-0.1 or 0.4~1.0																	
	match																		
crater (self-holding) "OFF"	↔																		
 CAUTION	If the settings do not agree, the welding operation may not proceed as set. Be sure to make the crater filling (self-latching) settings agree.																		

<p>0005 </p>	<p>Welding return distance setting Setting range : 0~999.9mm 0~39.4inch Factory default : 0mm 0inch ※ It can be also set in RETURN OF SELECT SWICTH. ※The welding current during the welding return waiting time varies depending on the crater filling (self-latching) ON/OFF setting.</p> <table border="1" data-bbox="472 398 1222 506"> <tr> <td>crater (self-latching)"ON"</td> <td>crater (self-latching)"OFF"</td> </tr> <tr> <td>Welding with crater current</td> <td>Welding with main current</td> </tr> </table> <p>※Precautions on Use Be sure to make the crater filling (self-latching) setting at the welding power source and that at the carriage agree. Set the crater filling (self-latching) switch of the welding power source according to the following table. Please set in "parameter setup mode No.0003" the setting method of the truck side.</p> <table border="1" data-bbox="472 741 1342 943"> <tr> <td>Welding power supply side</td> <td></td> <td>carriage side</td> </tr> <tr> <td>crater (self-latching) "ON"</td> <td>↔ match ↔</td> <td>-0.1 or 0.4~1.0</td> </tr> <tr> <td>crater (self-latching) "OFF"</td> <td>↔ ↔</td> <td></td> </tr> </table> <table border="1" data-bbox="472 965 1342 1081"> <tr> <td style="text-align: center;"> CAUTION</td> <td>If the settings do not agree, the welding operation may not proceed as set. Be sure to make the crater filling (self-latching) settings agree.</td> </tr> </table>	crater (self-latching)"ON"	crater (self-latching)"OFF"	Welding with crater current	Welding with main current	Welding power supply side		carriage side	crater (self-latching) "ON"	↔ match ↔	-0.1 or 0.4~1.0	crater (self-latching) "OFF"	↔ ↔		 CAUTION	If the settings do not agree, the welding operation may not proceed as set. Be sure to make the crater filling (self-latching) settings agree.
crater (self-latching)"ON"	crater (self-latching)"OFF"															
Welding with crater current	Welding with main current															
Welding power supply side		carriage side														
crater (self-latching) "ON"	↔ match ↔	-0.1 or 0.4~1.0														
crater (self-latching) "OFF"	↔ ↔															
 CAUTION	If the settings do not agree, the welding operation may not proceed as set. Be sure to make the crater filling (self-latching) settings agree.															
<p>0006 </p>	<p>Welding return speed settings Setting range : 50~1500mm/min 2.0~59.0inch/min Factory default:200mm/min 7.9inch/min ※ It can be also set in RETURN SPEED OF SELECT SWICTH.</p>															
<p>0007 </p>	<p>Welding frequency settings Setting range : 0~999time Factory default : 0time ※ It can be also set in COUNT OF SELECT SWICTH.</p>															
<p>0008 </p>	<p>Torch switch signal minimum time setting Setting range : 0.4~1.5s Factory default : 0.7s Sets the time to guarantee the ON/OFF state of the torch switch. Reducing this value may mean that the welding power source is unable to receive a signal, so care is required.</p>															
<p>0009 </p>	<p>Speed, Position Display Unit, Inch Setting  : Metric  : Inch The displayed set value of speed and distance can be switched in metric and inches. Refer to "switch over method of metric and inch" for method to switch. After setting this parameter, switch the power off and back on. ※ The factory default is the metric specifications.</p>															

	<p>Speed and Movement Position Correction Setting range : 50~200% Factory default : 100% Sets the value for correcting the actual speed with respect to the speed indicated at the digital display. Actual speed = speed displayed × [This parameter value]%</p>
	Not used
	Not used
	Not used

5.2.3 Metric, Inch switch over method

1. Turn ON the electric supply.
2. Select "SET" in selection switch and turn ON the START/STOP switch for once.
3. Turn the DATA DIAL and select , then turn ON START/STOP switch for once.
4. Select  or  and then turn ON the START/STOP switch for once.

 : Metric specification (mm)

 : Inch specification (inch)

5. Turn OFF the electric supply.
6. Turn ON electric supply again.
7. Turn OFF electric supply after display of speed.
8. Turn ON electric supply again(Changing over completion)

※ Initial setting is Metric specification.

※ While using in Inch specification, kindly change it to Inch specification by above mentioned operation while changing internal board.

※ Kindly keep interval between turning ON/OFF of electric supply for more than 2 seconds.

※ Kindly carry out verification by traveling speed display after completion of changing over.
(10~1500mm specification, 2.0~59.0 Inch specification)

5.2.4 Operation Pattern Diagram



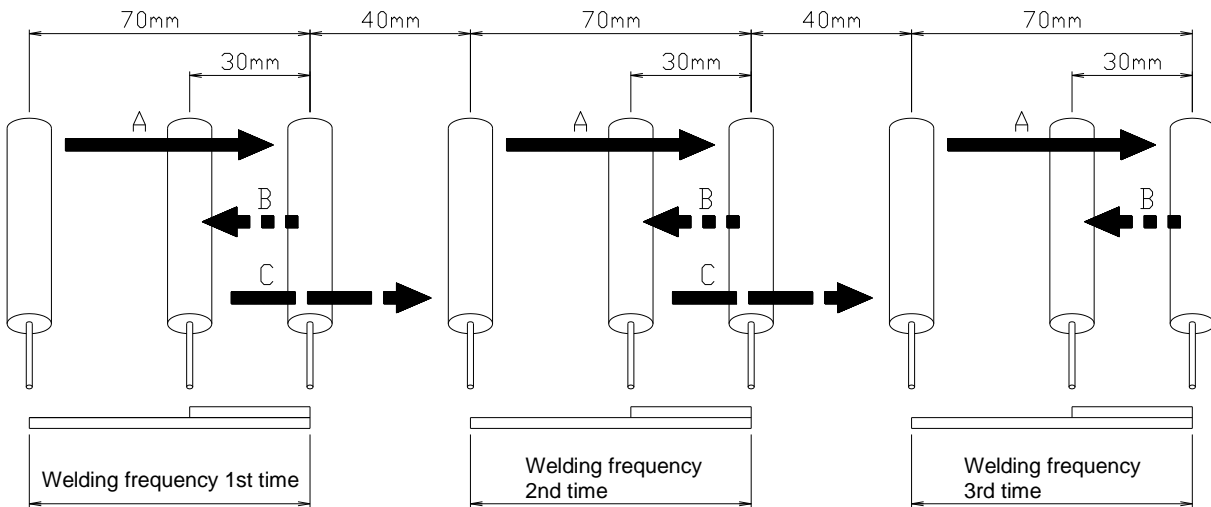

Example 1) Parameter setting value of tack/stitch welding

Welding distance	70mm/2.76inch	Operation sequence	Movement
Welding return distance	30mm/1.18inch	A	→ Welding movement
Preliminary feeding distance	40mm/1.57inch	B	←····· Welding return distance
Welding frequency	3times	C	---→ preliminary feeding distance
Without self-holding setting			



Example 2) Parameter setting value of tack/stitch welding

Welding distance	70mm/2.76inch
Welding return distance	30mm/1.18inch
Preliminary feeding distance	40mm/1.57inch
Welding frequency	3times
Welding return waiting time	1sec
Setting of the crater (self-holding)	ON

Operation sequence	Movement
A	 Welding movement
B	 Welding return distance
B'	 Crater current
C	 preliminary feeding distance

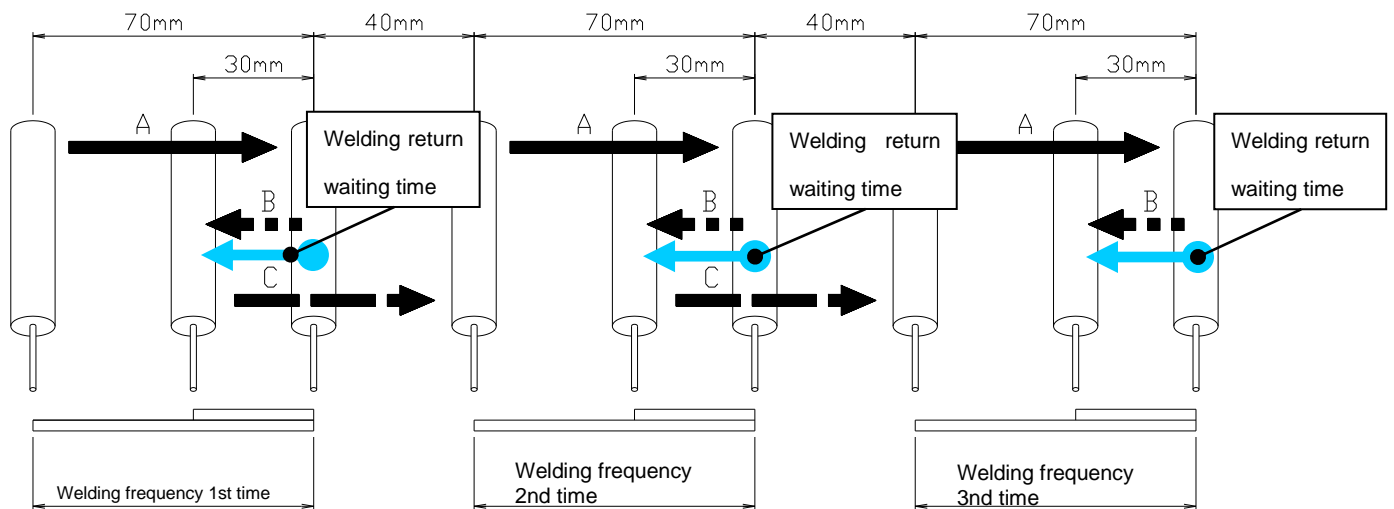

- ※ When welding power supply and crater setting of carriage are ON, weld the part  with the crater current.
- ※ In case of "0" welding frequency, it operates TACK/STITCH repetitively till carriage is stopped.
- ※ Only at the time of pressing of Limit switch during welding movement, welding movement is terminated at that point and it shifts to welding return operation. Further at the point of end of welding return operation, travelling and welding operations are stopped.
- ※ When START/STOP button is pressed, it stops travelling and welding at that point of pressing of button during any of the operation.

Further, "Welding distance", "Preliminary feeding distance", "Welding return distance" can be changed by operating "Arc changing over switch" during TACK/STITCH welding operation. Kindly operate by referring to below mentioned settings while changing distance during TACK/STITCH welding operation.

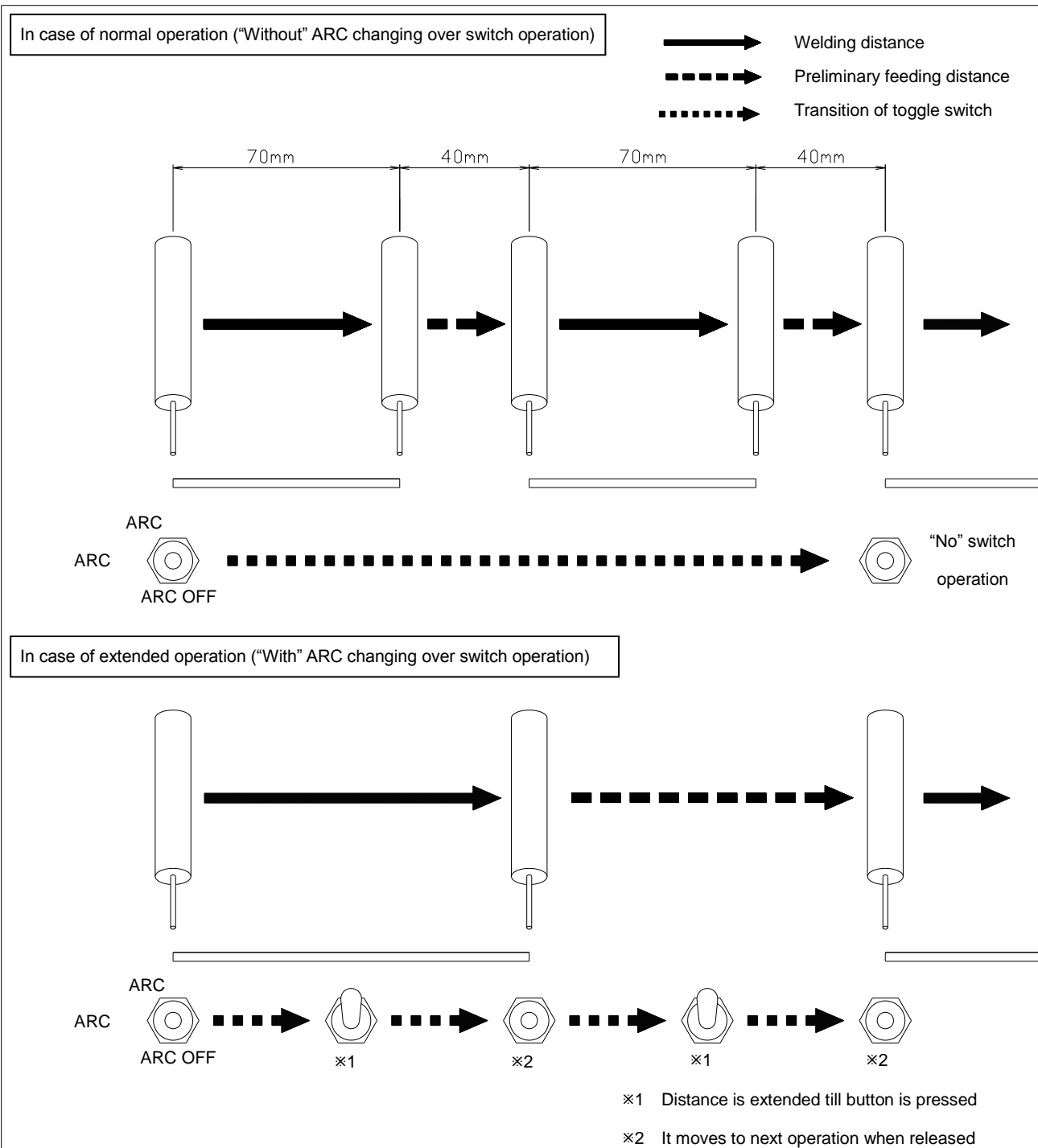

5.2.5 Time chart

Crater (self-holding)"OFF" setting

- A Arc stability waiting time 0s
- B Welding return waiting time 0s
- C Welding return distance 0mm(0inch)

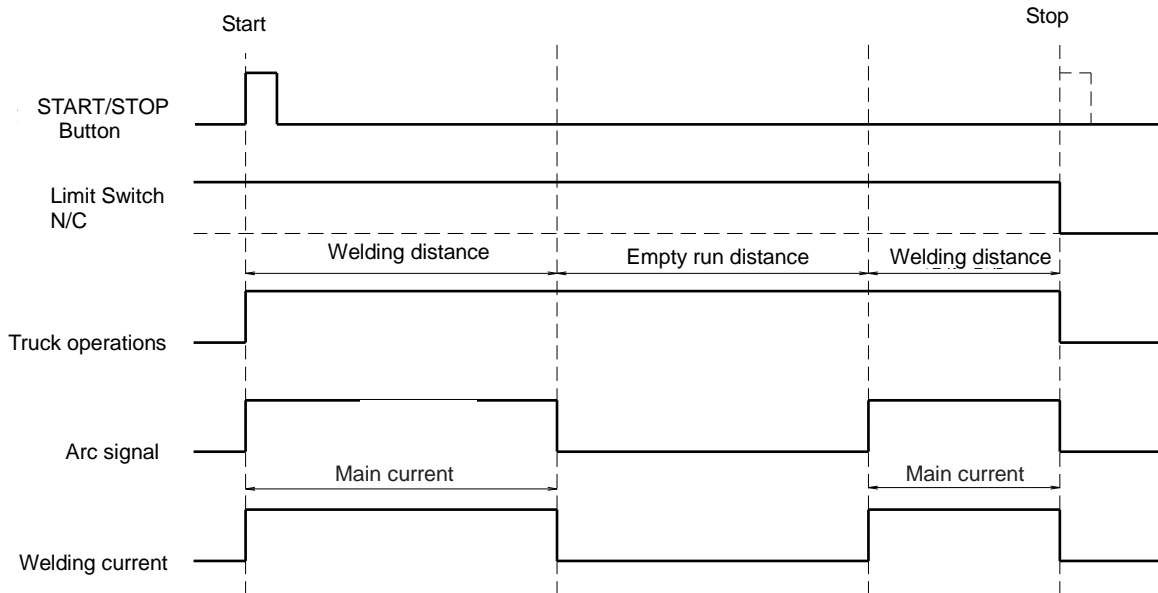

Crater (self-holding)"ON" setting

- A Arc stability waiting time 0s
- B Welding return waiting time 0s
- C Welding return distance 0mm(0inch)

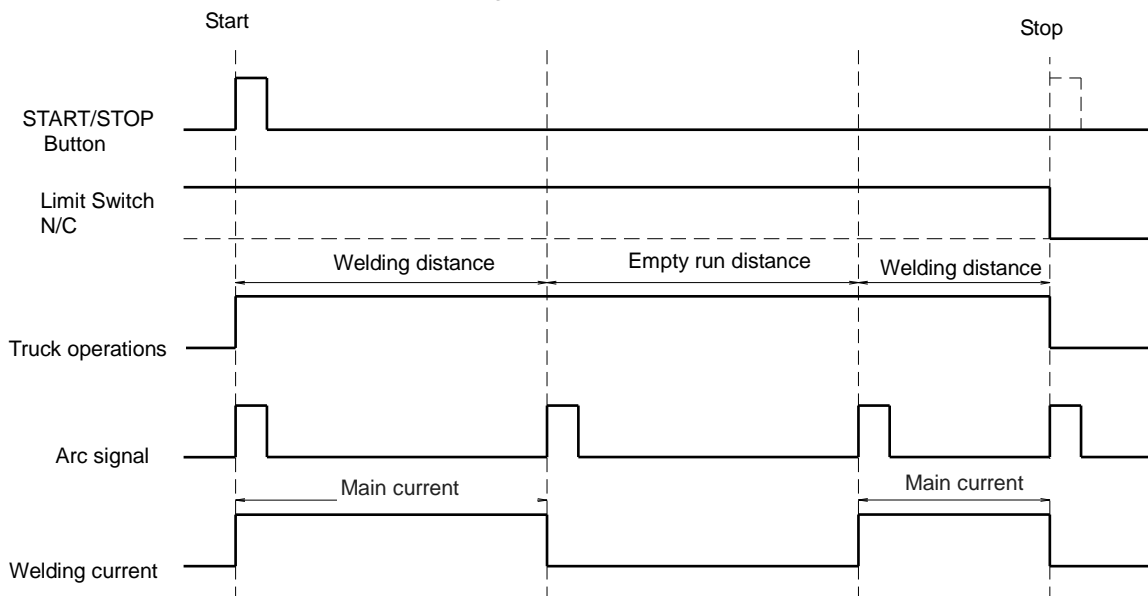

Crater (self-holding)"OFF" setting

- A Arc stability waiting time 1.0s
- B Welding return waiting time 1.0s
- C Welding return distance 5mm(0.19inch)

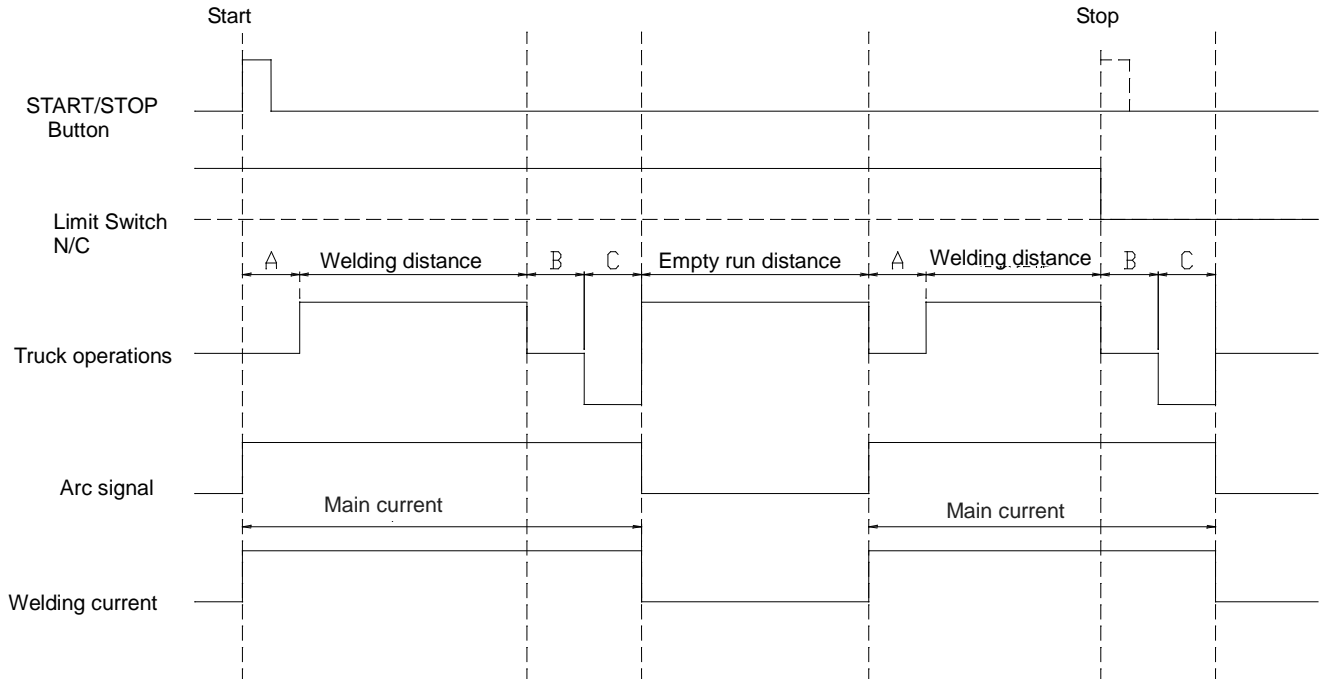

Crater (self-holding)"ON" setting

- A Arc stability waiting time 1.0s
- B Welding return waiting time 1.0s
- C Welding return distance 5mm(0.19inch)

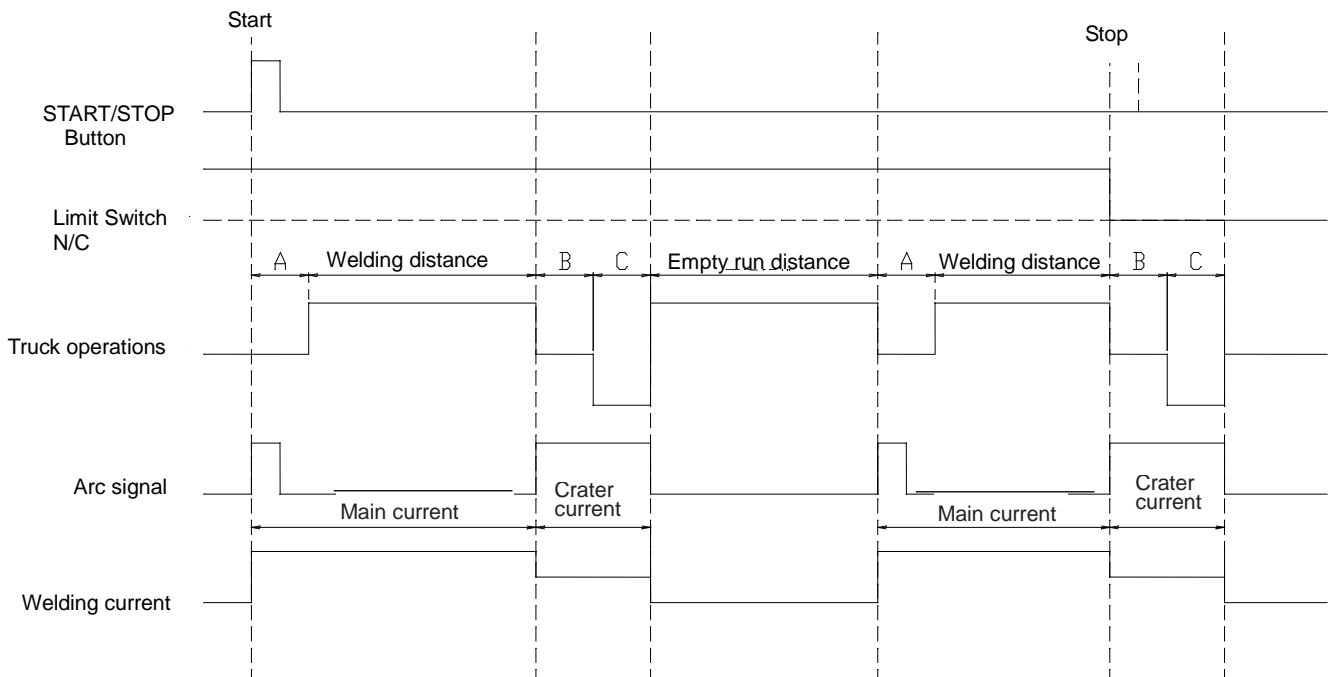







 CAUTION	<p>Since welding is carried out in Arc stability time by initial Arc current, it is necessary to set initial Arc settings at welding current end. Though Arc stability time at carriage end is from start to last, it is from the time of pressing of START/STOP button (Arc signal ON) till travelling of carriage. Kindly verify operation manual of welding current for initial Arc setting.</p>
---	---

 CAUTION	<p>It does not correspond to the welding current click adjustment function which gradually increases and decreases the welding current during main welding</p>
---	--

5.3 Preparation and procedure for welding

Conduct welding in the following manner, while referring to the Fig. 6 “System connection diagram” and the operation procedure in item 5.

 WARNING	<p>Strictly observe the following to prevent electric shock.</p>
	<ul style="list-style-type: none"> ■ Turn OFF the control power and welding power, and then conduct operations from (1) to (4) shown below. ■ When you remove the plug, put rubber cap on the receptacle to prevent dust and dirt. ■ When you found dust and dirt in the receptacle, remove these before connecting electric power cable plug.

 WARNING	<p>Please observe that the following.</p>												
<p>Always match the setting of the crater (self-holding) on the welding power supply side and the carriage side If the settings are not match, the carriage malfunctions and can not be welded properly. Also, the arc can not be cut off when the carriage stops. Please set the crater (self-holding) switch of the welding power supply according to the table below so that the settings match. Please set in “parameter setup mode No.0003” the setting method of the truck side.</p>													
<table border="1" style="width: 100%;"> <thead> <tr> <th style="width: 50%;">Welding power supply side</th> <th style="width: 10%;"></th> <th style="width: 40%;">carriage side</th> </tr> </thead> <tbody> <tr> <td>crater (self-holding) "ON"</td> <td style="text-align: center;">↔</td> <td>-0.1 or 0.4~1.0</td> </tr> <tr> <td></td> <td style="text-align: center;">match</td> <td></td> </tr> <tr> <td>crater (self-holding) "OFF"</td> <td style="text-align: center;">↔</td> <td style="text-align: center;"></td> </tr> </tbody> </table>	Welding power supply side		carriage side	crater (self-holding) "ON"	↔	-0.1 or 0.4~1.0		match		crater (self-holding) "OFF"	↔		
Welding power supply side		carriage side											
crater (self-holding) "ON"	↔	-0.1 or 0.4~1.0											
	match												
crater (self-holding) "OFF"	↔												
 CAUTION	<p>If the settings are not met, the welding operation may not be set according to the setting. Please use to match the crater (self-holding) setting.</p>												

- (1) Connect power cable to Receptacle of operation unit. (By connecting power cable, it turns ON LED on Digital meter and "RDY" at the same time. It also turns ON LED of "ARC" when ARC changing over switch is on ARC ON position)
- (2) Mount the exclusive use torch on the torch holder.

**CAUTION**

When tightening the torch holder, use the accompanying wrench bar or other tools in an appropriate size.

- Improper tool can cause unexpected injury.

- (3) Connect the torch to the mating wire feeder.
- (4) Connect the 2-core metal plug of the control cable to the metal socket of the wire feeder and the input power plug to the nearest outlet.
- (5) Turn ON the power switch of the welding power supply and insert the wire into the torch. (Insert the torch cable straightly.)

**CAUTION**

When inserting the wire, do not bring your head near the wire that comes out of the tip.

- Your eyes can be damaged.

- (6) Press the tracing roller against the vertical plate, and set the carriage in the welding position.
- (7) For attraction by magnet, incline the magnet lever as shown in Fig.3.
- (8) Turn the handle of the slide unit assembly (UP/DOWN or FRONT/REAR) for torch position alignment.
- (9) Select each parameter by SELECT SWITCH and set parameter value by DATA DIAL.
- (10) Match SELECT SWITCH to either of continuous travelling mode or TACK/STITCH travelling mode settings after completion of each parameter settings. (it matches with operation unit directing arrow display part.)
- (11) Turn DATA DIAL and set travelling speed.
(LED of "BSY" turns ON during carriage operation and LED of "WEL" turns ON during ARC generation)

**CAUTION**

To back up the set parameters, once the power to OFF Please restart.

- Truck and WU-3R will back up the parameters OFF Then set the power during the stop.
OFF the power during the operation result, it can not be backed up correctly Parameter.

- (12) Determine the start position.
※Positioning of carriage (fine tuning) can be carried out easily by pressing Limit switch.
- (13) Finely adjust the welding conditions (current, voltage, speed, etc.) as necessary.
- (14) Press START/STOP button, and start welding. (Arcs will be generated at the same time.)

**CAUTION**

Pay attention to the following during welding.

- Wear a welding mask, face guard, and welding protectors to protect yourself from arc light, fumes, and spatters.

- (15) Finely adjust the welding conditions (current, voltage, speed, etc.) as necessary.
(16) Welding can be stopped by means of the stop switch or auto stop switch. (While the carriage stops, arcs stop at the same time.)

**CAUTION**

When the crater (self-hold) setting is "ON", please pay attention to the following.

- When the crater (self-holding) setting is "ON", there is no synchronization function from the welding power source side, so if the arc interruption during welding operation, the subsequent movement of the carriage may not match the welding operation.
- If the arc runs out and you stop running the carriage, you can prevent it by turning off the welding power supply and turning it back on again.
- For information about problems at the time of arc interruption, please refer to the “**6.3 Maintenance and inspection * The trouble operation at the time of arc interruption occurs**”.

5.4 System connection diagram

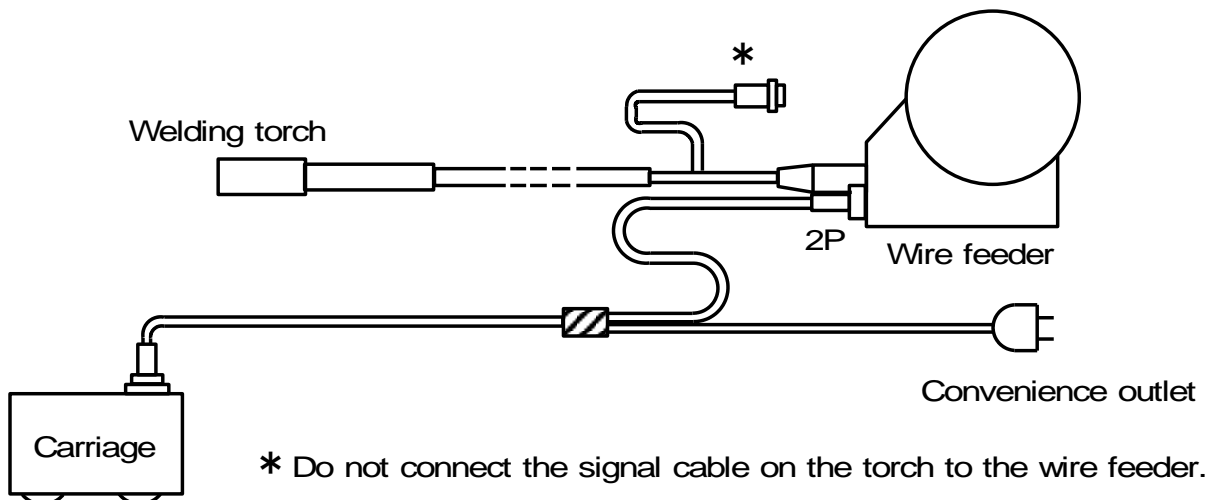

Fig.6 System connection diagram

5.5 Applicable welding machine and signal adaptor

This welding machine is to be used in combination with a semi-automatic (CO₂, MAG) welding machine (power supply and feeder) available on the market.

The only electric signal interface with the welding machine is the torch signal, and the welding machine outputs (relay A-contact point) a self-holding type signal. Set the switch on the welding power supply side in the "No Self-Holding" position.

The signal cable plug is D25-2P (connectable to wire feeders made by Matsushita or Daihen).

Plugs for connection to wire feeders of other manufacturer are also available as options. Contact us in that case. Contact the manufacturer of the wire feeder you use for purchasing a correct torch that matches the feeder.



(Note) The welding cable, gas hose and torch switch cable must be connected to the wire feeder. The connecting hardware and connector differ according to power supply manufacturer. Use the correct ones.

5.6 Operational precautions

- 1) Make sure that the operating voltage is as specified, If the difference exceeds plus or minus 10% of the input power, trouble can occur.
- 2) Clean the traveling surface to remove remaining bars, slugs, spatters, etc. before starting welding. (For prevention of slippage during welding.)
- 3) When long cables are necessary, take appropriate measures for the cables to prevent catching or entanglement by means of a jig crane, etc.

6 Maintenance

For correct operation of the machine for an extended period of time without trouble, the daily maintenance is indispensable. (Refer to 6.1 "Maintenance and inspection.")
When trouble occurs, refer to 6.3 "Trouble and corrective measures."

 WARNING	Kindly take care about following things to avoid getting an electric shock.
	<ul style="list-style-type: none"> ■ Kindly remove input plug from outlet while checking, dis-assembling or repairing and turn OFF the control source while leaving. If it is necessary to carry out checking in the energized state, professional engineer having enough knowledge and skill about electric handling should go since there is risk of short circuit, getting electric shock.
<ul style="list-style-type: none"> ■ Do not use welding equipment without case or cover. ■ Please use input plug with ground connection possible, ground connection. It connects with the carriage body inside the operation panel. ■ Kindly use input voltage within $\pm 10\%$ for power supply input to input plug. There is risk of short circuit due to failure of printed board on operation panel. ■ In case of crack in insulation cover of power cable and torch cable, do not expose it to high temperature. There is risk of short circuit due to tearing of insulation covering. ■ Kindly weld below the rated current and usage rate of torch to prevent dielectric breakdown due to overheating. ■ Kindly place power cable and torch cable in proper manner so that they are not stretched or pulled. There is possibility of breakage of insulation by damaging holding part and connector part due to pulling. ■ Do not throw or drop main body of carriage. There is risk of damaging insulation by breaking. ■ While connecting to power cable plug to main body, kindly connect after verifying that foreign object is not touching to connector of main body, power cable plug. There is risk of connector erosion due to short circuit by foreign object. 	

	WARNING
As for the attachment, removal of the drive wheel, please use 2 spanners without fail.	
<ul style="list-style-type: none"> ■ Hold the driving wheel of the other side, when attaching or removing the driving wheels. And then loosen the hexagon nut on the side of attaching or removing the driving wheels. There is the possibility that damages the part of drive relation. 	

6.1 Maintenance and inspection

6.1.1 Daily inspection

- (1) Clean the nozzle and check the tip for abrasion.
- (2) Clean wheels. (Removal of iron powder etc.)
- (3) Check guide rollers for smooth rotation. (Cleaning)
- (4) Remove spatters from the carriage.













6.1.2 Monthly inspection

- (1) Check the locking screws of the motor bracket, torch holder, tracing arm, handle, carriage bottom plate, etc. for looseness.
- (2) Check cables (torch and control) for twisting or broken sheathing.
- (3) Confirmation of the operation of auto stop limit switch.
- (4) Confirmation of smooth operation of the control unit by means of the front/rear, up/down control knob.
- (5) Check the switches on the operation panel for looseness or breakage, and confirm the operation of switches.
- (6) Clean the conduit liner of the torch.
- (7) Check the operation panel, switches, and controls for looseness or breakage. Check their operation.
- (8) Check whether the magnet behavior is not hard. Apply grease when operation is stiff (Refer to parts list for specified grease)

6.2 Recommended spare parts

- (1) Guide roller
- (2) Driving wheel
- (3) Switches
- (4) Printed circuit board

6.3 Trouble shooting

Defects	Cause/check position				
(1) Slipping off of profiling while traveling	1) Guide roller is not rotating. 2) Cable is stuck in and it is blocking smooth traveling of carriage. 3) Traveling surface is not smooth and wheel cannot touch the surface. 4) Lot of sputter is adhered on driving roller and carriage is not rotating smoothly.				
(2) No electric power supply	1) No power supply voltage to outlet. 2) Cable is disconnected. <table border="1" data-bbox="619 622 1390 987"> <tr> <td data-bbox="619 622 884 730">  WARNING </td> <td data-bbox="890 622 1390 730"> Kindly take care about following things to avoid getting an electric shock. </td> </tr> <tr> <td data-bbox="619 739 884 987">  </td> <td data-bbox="890 739 1390 987"> ■ Since above mentioned 1) and 2) checking are to be carried out while control power supply is ON, professional engineer having enough knowledge and skill about electric handling should go to prevent risk of short circuit, getting an electric shock. </td> </tr> </table>	 WARNING	Kindly take care about following things to avoid getting an electric shock.		■ Since above mentioned 1) and 2) checking are to be carried out while control power supply is ON, professional engineer having enough knowledge and skill about electric handling should go to prevent risk of short circuit, getting an electric shock.
 WARNING	Kindly take care about following things to avoid getting an electric shock.				
	■ Since above mentioned 1) and 2) checking are to be carried out while control power supply is ON, professional engineer having enough knowledge and skill about electric handling should go to prevent risk of short circuit, getting an electric shock.				
(3) Traveling speed of carriage is not changing	<table border="1" data-bbox="619 1043 1390 1541"> <tr> <td data-bbox="619 1043 884 1173">  WARNING </td> <td data-bbox="890 1043 1390 1173"> Kindly take care about following things to avoid getting an electric shock. </td> </tr> <tr> <td data-bbox="619 1182 884 1541">  </td> <td data-bbox="890 1182 1390 1541"> ■ Kindly carry out continuity check by tester while electric supply is turned OFF. ■ Since above mentioned 2) and 3) checking are to be carried out while control power supply is ON, professional engineer having enough knowledge and skill about electric handling should go to prevent risk of short circuit, getting an electric shock. </td> </tr> </table> 1) Defective motor 2) Defective printed board 3) Disconnection of motor encoder line	 WARNING	Kindly take care about following things to avoid getting an electric shock.		■ Kindly carry out continuity check by tester while electric supply is turned OFF. ■ Since above mentioned 2) and 3) checking are to be carried out while control power supply is ON, professional engineer having enough knowledge and skill about electric handling should go to prevent risk of short circuit, getting an electric shock.
 WARNING	Kindly take care about following things to avoid getting an electric shock.				
	■ Kindly carry out continuity check by tester while electric supply is turned OFF. ■ Since above mentioned 2) and 3) checking are to be carried out while control power supply is ON, professional engineer having enough knowledge and skill about electric handling should go to prevent risk of short circuit, getting an electric shock.				
(4) No welding operation and no traveling of carriage at the pressing of START/STOP button while stopping of carriage	1) Limit switch at carriage traveling direction side is pressed. × Carriage starts traveling by pressing Limit switch which is at opposite side of carriage traveling direction. 2) Defective START/STOP button 3) Defective printed board 4) Defective Limit switch or disconnection Limit switch				
(5) There is welding operation but no traveling of carriage at the pressing of START/STOP button while stopping of carriage	1) Defective printed board 2) Disconnection of motor (disconnection of DC line or disconnection of both DC line and encoder line)				

<p>(6) There is traveling of carriage but no welding operation at the pressing of START/STOP button while stopping of carriage</p>	<p>1) ARC OFF option is selected in Arc mode changing over switch. 2) No welding current. 3) The signal cable for the torch switch is not connected to the welding power supply. 4) Check for a short circuit between the 2pins of the 2-pin metal outlet for the torch switch (see figure below) on our cable. If it is a dedicated torch, check for a short circuit between the 2pins of-the 2pmetal outlet for the torch switch connected to the feeder.</p> <ul style="list-style-type: none"> ▪ In case of short circuit, welding current is defective ▪ In case of no short circuit, there must be disconnection of cable , defective printed board  <p>Connector shape reference</p>				
<p>(7) No stopping of welding operation and traveling of carriage at the pressing of START/STOP button during welding operation</p>	<p>1) Defective START/STOP button 2) Defective printed board</p>				
<p>(8) There is stopping of traveling of carriage but no stopping of welding operation at the pressing of START/STOP button during welding operation.</p>	<p>1) Should be “with Self holding” option selected at welding current. * Kindly set it to “Without self-holding”. 2) Defective printed board.</p>				
<p>(9) There is stopping of welding operation but no stopping of traveling of carriage at the pressing of START/STOP button during welding operation</p>	<p>1) Defective printed board</p>				
<p>(10) No stopping of welding and traveling of carriage even at pressing of Limit switch</p>	<p>1) Limit switch is not pressed completely. 2) Defective Limit switch *Kindly verify conduction of terminal 1- terminal 4 of Limit switch by tester. At normal conduction, it makes “click” sound at pressing of Limit switch and it turns OFF the conduction between terminals at the same time.</p> <table border="1" data-bbox="619 1751 1417 1948"> <tr> <td data-bbox="635 1765 721 1841"> </td> <td data-bbox="730 1751 1407 1854"> <p>WARNING Kindly check the conduction between terminals by tester while electric supply is turned OFF.</p> </td> </tr> <tr> <td colspan="2" data-bbox="635 1863 1407 1948"> <p>■ If electric supply is turned ON during verification of conduction between terminals by tester, there is risk of electric shock due to short circuit.</p> </td> </tr> </table>		<p>WARNING Kindly check the conduction between terminals by tester while electric supply is turned OFF.</p>	<p>■ If electric supply is turned ON during verification of conduction between terminals by tester, there is risk of electric shock due to short circuit.</p>	
	<p>WARNING Kindly check the conduction between terminals by tester while electric supply is turned OFF.</p>				
<p>■ If electric supply is turned ON during verification of conduction between terminals by tester, there is risk of electric shock due to short circuit.</p>					

(11) There is stopping of traveling of carriage but no stopping of welding operation at pressing of Limit switch	1) Should be "with Self holding" option selected at welding current. * Kindly set it to "Without self-holding". 2) Defective printed board.
(12) There is stopping of welding operation but no stopping of traveling of carriage at pressing of Limit switch	1) Defective printed board
(13) Absorption force is not weaken even at drawing off magnet lever	1) Defective magnet rotation shaft *If the rotating shaft broken it must be changed.
(14) Display of Digital meter does not changed even after turning of SELECT SWITCH	1) Defective printed board. 2) Disconnection of electric wire
(15) Numeric value of parameter does not change	1) Defective printed board. 2) Disconnection of electric wire
(16) There is huge difference between parameter setting Welding distance, free travelling distance, welding return distance and actual travelled distance	1) Wearing off of Rubber roller. * Kindly change it to new product.
(17) Digital display of speed units are different from the settings which are used.	1) There is possibility that the setting of Metric and inch specifications are different from the used specification. Switch the unit on the basis of the switching method of operation. Refer to " ※metric, inch switch over method " for changing method. ※Be sure that metric inch switching operation is done when the board is replaced.
(18) When self-holding "ON", arc runout occurs while the truck is running, and the movement of the truck and welding does not match	1) When the crater (self-holding) setting is "ON", there is no synchronization function from the welding power source side, so if the arc interruption during welding operation, the subsequent movement of the carriage may not match the welding operation. ※If the arc runs out and you stop running the carriage, you can prevent it by turning off the welding power supply and turning it back on again.
(19) There is a wobble on Slide unit	Adjust the hexagon socket set screw M4 on the side of slide unit. Adjustment screws and fixing screws are provided in one hole.
(20) It is hard behavior of the magnet lever	1) No grease of the sliding portion of the magnet lever and MG bracket 2) Marked with foreign matter Decompose, coated with grease (Refer to parts list for specified grease)

*** The trouble operation at the time of arc interruption occurs**

When the crater (self-holding) setting is "ON", there is no synchronization function from the welding power source side, so if the arc interruption during welding operation, the subsequent movement of the carriage may not match the welding operation.

example) Self-holding (crater) setting "ON" A : Arc stability time B : Welding return waiting time
C : Welding return distance D : Preliminary feeding distance

▪ In case of normal operation

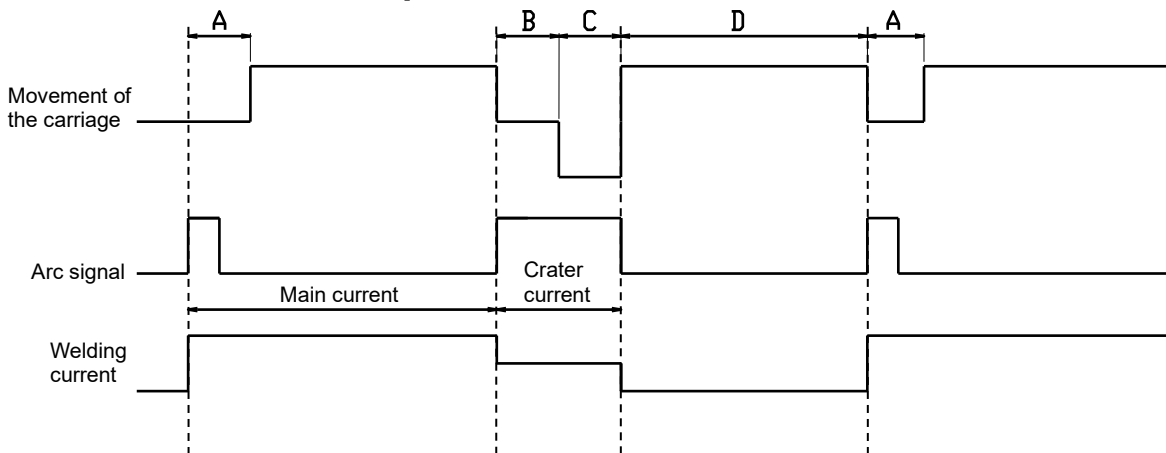

▪ Example of arc interruption occurrence and erroneous operation

Because an arc interruption occurred, stop the carriage with the START / STOP button

Start again with the START / STOP button

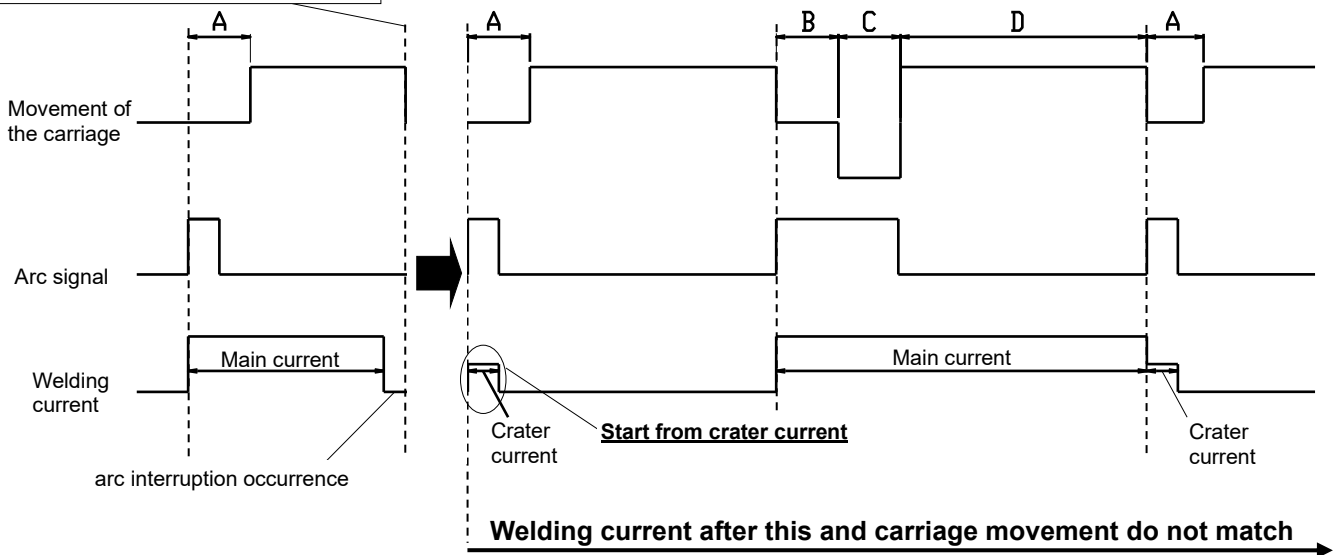

coping strategy	If arc interruption occurred and the running of the dolly is stopped, please take this countermeasure.
<p>● When stopping the running of the dolly, please turn off the welding power supply and turn the power on again. It is possible to prevent deviation between welding current and truck movement.</p>	

6.4 Warranty

This is thoroughly inspected and tested before leaving the factory, and guaranteed for 12 months from the date of purchase against defective workmanship and material. Should any trouble develop, return the complete equipment prepaid to KOIKE Sanso Kogyo Co., Ltd. Authorized KOIKE Distributor.

7 Wiring diagram

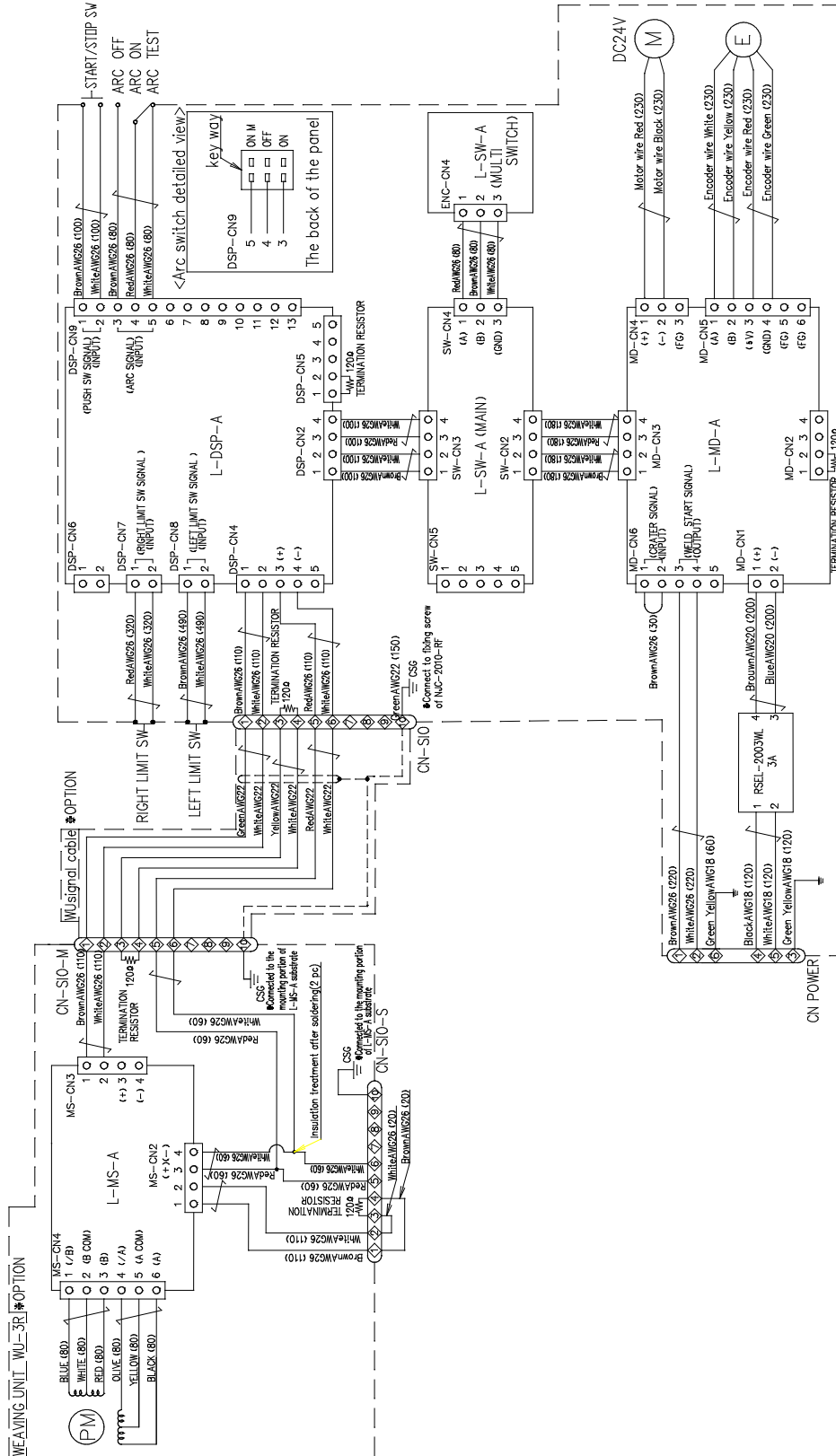

8 Assembly drawing of WEL-HANDY MULTI NEXT TACK/STITCH

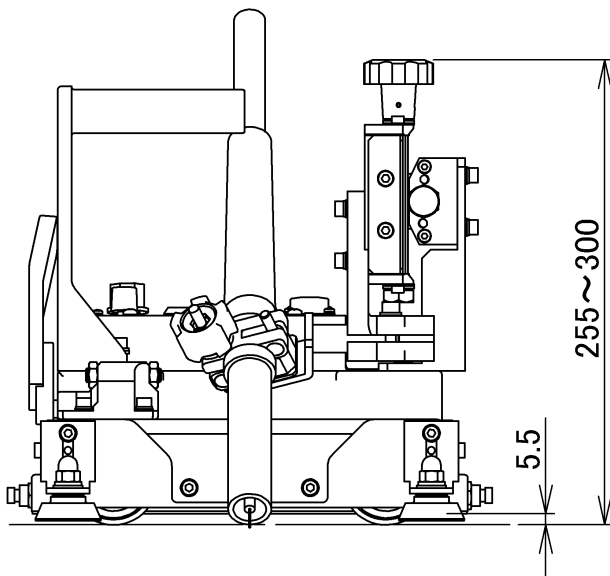
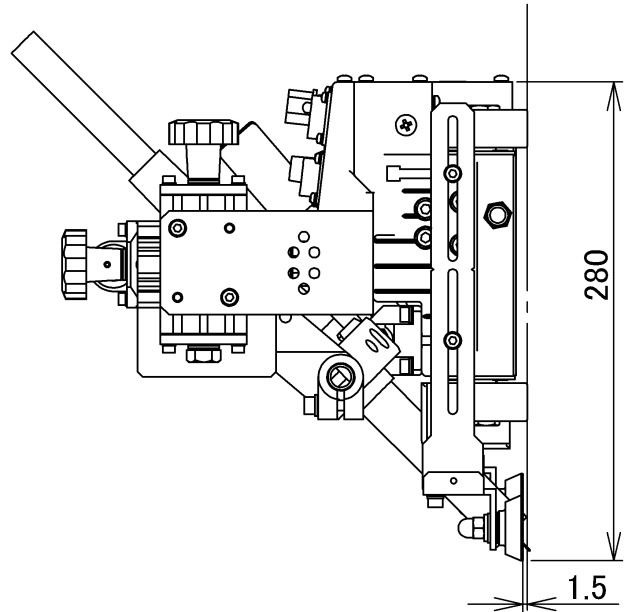
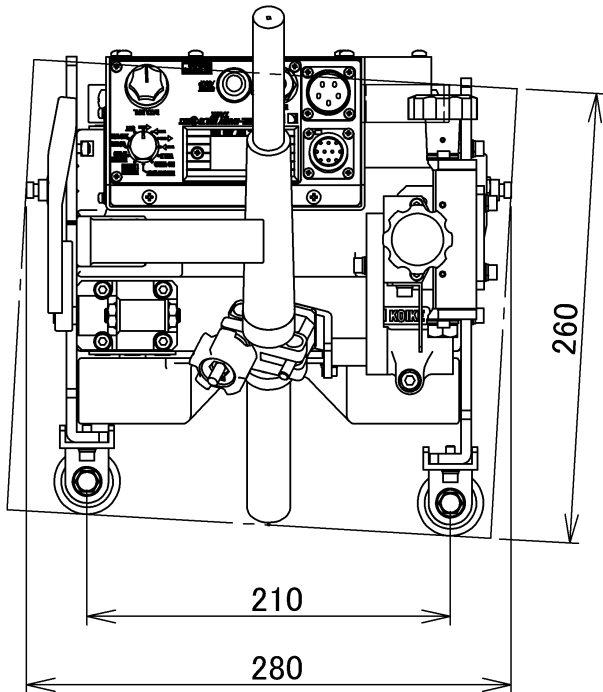

1.5mm	= 0.059inch
5.5mm	= 0.217inch
210mm	= 8.268inch
255mm	= 10.039inch
260mm	= 10.236inch
280mm	= 11.024inch
300mm	= 11.811inch

9 Parts list

9.1 Main body and inside parts

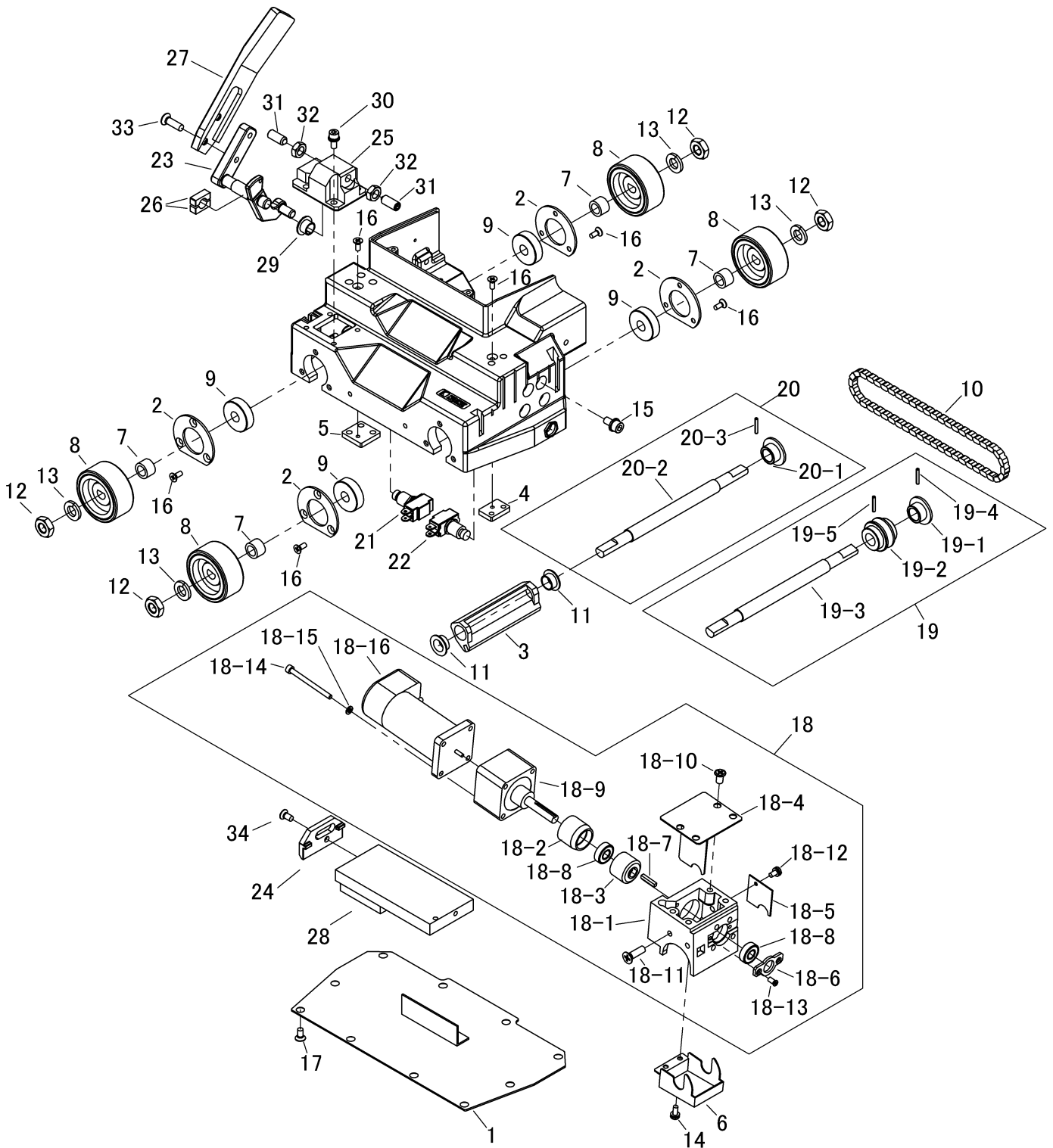

Main body and inside parts

ITEM No.	PART NAME	QTY	STOCK No	REMARKS
1	Under cover	1	20503581	
2	Bearing plate	4	20503582	
3	MG Holding block	1	20503558	
4	Mounting plate A	1	20503583	
5	Mounting plate B	1	20503584	
6	Gear box under cover	1	20503576	
7	Spacer	4	61007553	
8	Drive roller	4	61000579	
9	Bearing	4	6A036200	6200ZZ
10	Chain	1	67000012	RS15-82 コマ
11	DU bush	2	60034035	MB1206-20FDU
12	Nut	4	6D030100	NH-10
13	Spring washer	4	6D510100	WS-10
14	Screw	1	6C530410	SP-4×10
15	Hexagon socket head cap screw	4	6C440612	BC-6×12 (WS)
16	Screw	14	6C500408	SF-4×8
17	Screw	10	6C500510	
18	Gear box assembly	1	20504347	
18-1	Gear box	1	20503565	
18-2	Gear box bearing spacer	1	20503575	
18-3	Worm gear	1	61007941	
18-4	Gear box cover	1	20503577	
18-5	Gear box side cover	1	20503578	
18-6	Gear box bearing plate	1	20503579	
18-7	Key	1	20503768	
18-8	Bearing	2	6A030698	
18-9	Gear head	1	61007942	IG-43-KS51/49
18-10	Screw	4	20504668	M6×10
18-11	Screw	1	6C500608	SF-6×8
18-12	Screw	1	6C570410	SP-4×10
18-13	Screw	2	20504669	M4×8

ITEM No.	PART NAME	QTY	STOCK No	REMARKS
18-14	Hexagon socket head cap screw	4	6C030450	BC-4×50
18-15	Spring washer	4	6D510040	WS-4
18-16	Motor	1	61007939	
19	Drive shaft assembly	1	20504449	
19-1	Sprocket	1	20503665	※2
19-2	Worm wheel	1	61007940	※2
19-3	Motor wheel shaft	1	61000568	J4105-10A03-1 ※2
19-4	Spring pin	1	6B022518	PR-2.5×18
19-5	Spring pin	1	5A001065-Y	PR-3×22
20	Idle shaft assembly	1	20504450	
20-1	Sprocket	1	20503665	※2
20-2	Motor wheel shaft	1	61000568	J4105-10A03-1 ※2
20-3	Spring pin	1	6B022518	PR-2.5×18
21	Limit switch(R)	1	61006497	
21-1	Push button switch	1	64000171	
22	Limit switch(L)	1	61006470	
22-1	Push button switch	1	64000171	
23	MG lever	1	20503408	
24	MG bracket	1	20503574	
25	MG lever holder	1	20503569	
26	MG lever collar	2	20503573	
27	Lever	1	61000641	J4105-13B08
28	Standard magnet	1	61007944	
	50kg magnet	(1)	61000733	
29	DU bush	1	6D710718	MB1 007-18FDN
30	Hexagon socket head cap screw	4	6C450512	BC-5×12 (WF,WS)
31	Ball plunger	2	20503746	BSTH8A
32	Nut	2	6D030080	NH-8
33	Screw	2	6C500614	SF-6×14
34	Screw	1	6C500510	SF-5×10
35	grease	(1)	20505213	※1

※1 It is grease to be applied to the long hole of No.24 MG bracket and the shaft of No.23 MG lever.

※2 It is necessary to drill and pin the holes to match the actual product.

9.2 Outside parts

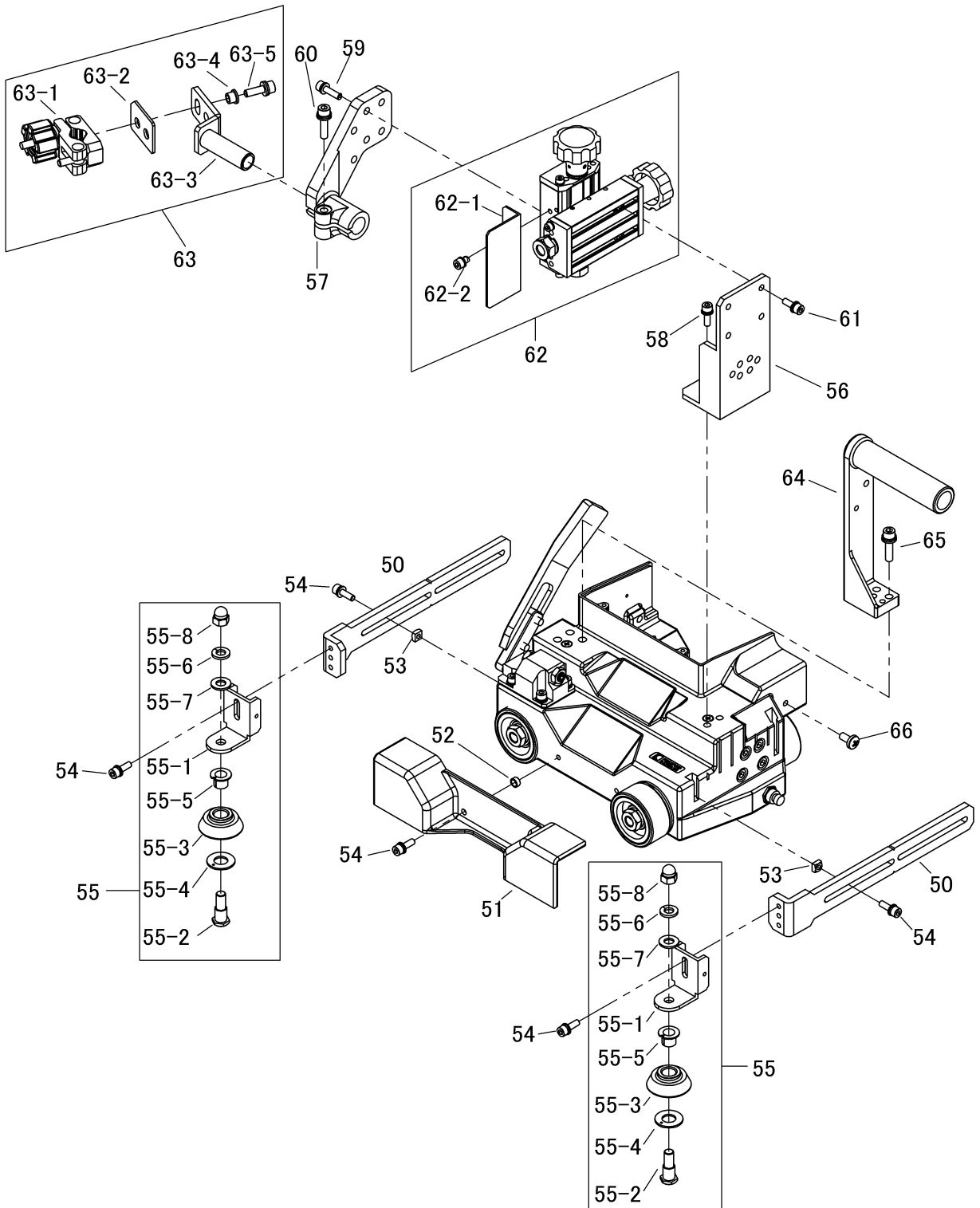

9.3 Electrical parts

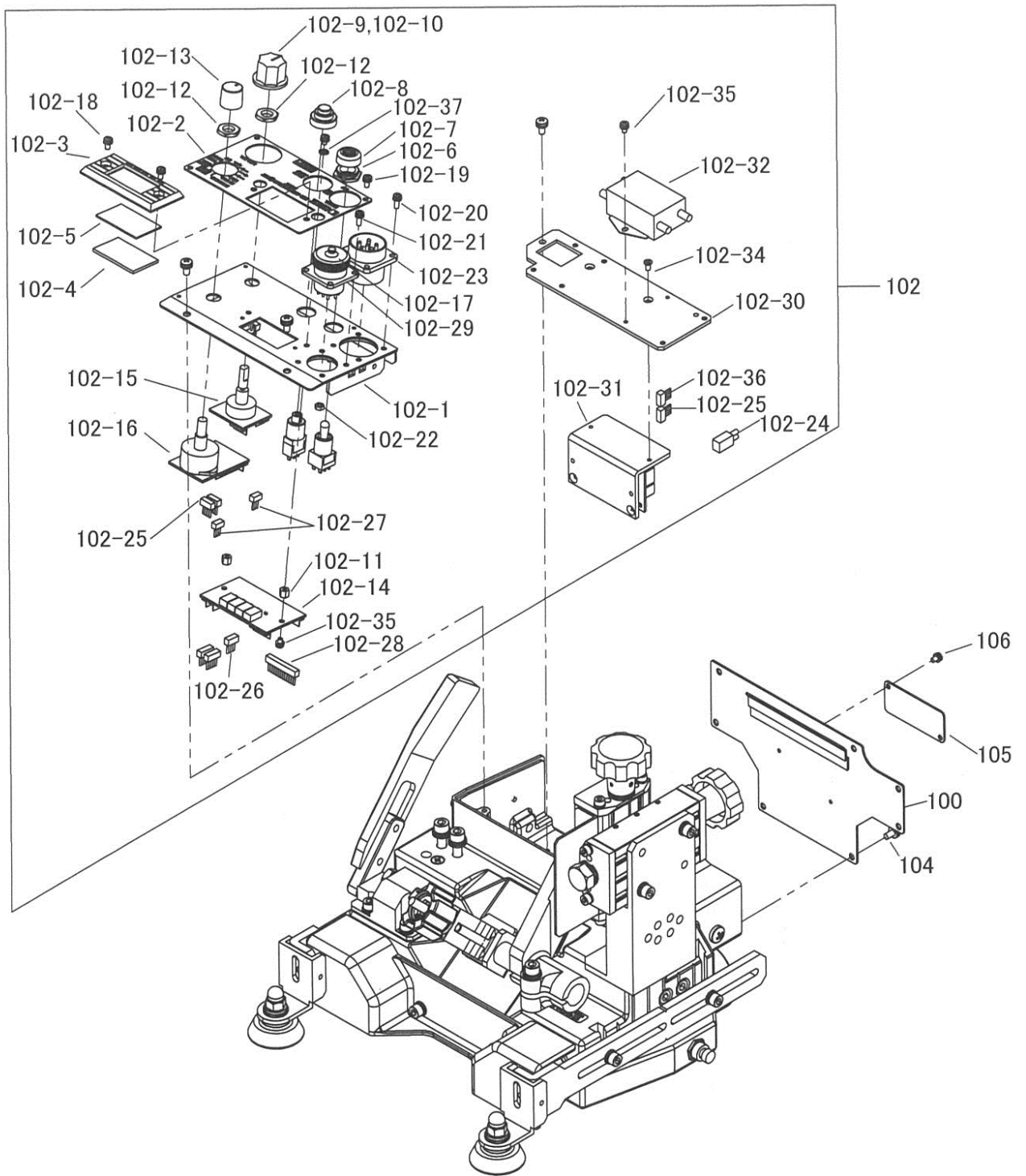

10 Inquiry counter

The inquiry counter is the following office.

Office name: KOIKE Europe B.V.

Address: Grote Tocht 19 1507 CG Zaandam The Netherlamds

Phone: +31(0)75 612 72 27

Email address: info@koike-europe.com

Internet homepage: www.koike-europe.com

**WEL-HANDY MULTI NEXT TACK/STITCH
OPERATION MANUAL**

Date of issue:	Nov.2018
2nd	Mar.2019
3rd	May.2019
4th	Jul.2019
5th	May.2020
6th	Nov.2020

KOIKE SANZO KOGYO CO.,LTD.

Printed in Japan